

Technical Data
Caractéristiques techniques

LTM 1300/1

Mobile Crane
Grue automotrice

Telescopic boom
Flèche télescopique

max. 197 ft

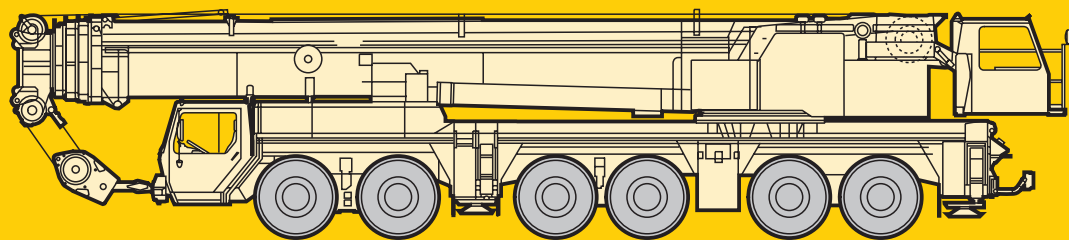

LIEBHERR

Lifting capacities on telescopic boom. Forces de levage à la flèche télescopique.

LTM 1300/1



49 ft – 197 ft



29' x 27'11"



360°



192500 lbs



85%

ft	49 ft		66 ft	83 ft	100 ft	117 ft	134 ft	151 ft	168 ft	185 ft	197 ft	ft
	*											
10	704	481										10
11	558	459										11
12	477	437	368									12
13	457	417	368									13
14	437	399	368	368								14
15	417	381	367	364								15
16	399	365	361	351								16
17	381	350	350	339	290							17
18	364	336	336	328	282							18
20	331	309	309	306	266	216						20
22	302	287	287	284	252	206						22
24	276	267	267	265	239	196	172					24
26	254	249	248	247	226	187	165					26
28	236	233	233	231	215	179	159	137				28
30	219	218	218	216	204	171	153	132	112			30
32	205	204	204	203	194	164	147	127	109			32
34	192	192	192	191	186	158	141	123	106	88.5		34
36	182	182	182	180	177	152	136	119	103	86.5		36
38	171	171	171	169	169	146	131	115	100	84.5		38
40			161	160	161	140	126	111	97.5	82.5	73.5	40
45			141	140	142	128	115	102	90.5	78	71	45
50			126	124	126	118	105	93.5	84	73.5	67	50
55			113	111	113	109	97	86.5	78	69.5	63.5	55
60			100	100	102	101	90	80	72.5	65	60.5	60
65				90.5	92.5	93.5	84	74	67.5	61.5	57.3	65
70				82.5	84.5	86.5	78.5	69.5	63	58.2	54.2	70
75					77	79.5	73.5	65	59.2	55	51.2	75
80					70.5	73	68.5	61	55.8	51.9	48.3	80
85					67	67	64.5	57.1	52.6	49.1	45.7	85
90					63.5	62	59.7	54.1	49.6	46.4	43.4	90
95						57.6	55.2	51.2	46.7	43.9	41.2	95
100						53.6	52.1	48.5	44.1	41.6	39.1	100
105							49.5	45.9	41.9	39.3	37.1	105
110							46.2	43.4	39.8	37.5	35.3	110
115							43.3	40.9	37.9	35.8	33.6	115
120							40.6	38.6	36	34.1	32.2	120
125								37.1	34.2	32.5	30.7	125
130								35.7	32.8	31	29.4	130
135								34.1	31.5	29.5	28.1	135
140								31.6	30	28.2	26.8	140
145									28.4	27.2	25.6	145
150									27.4	26.2	24.4	150
155									26.4	25.3	23.6	155
160										24.3	22.7	160
165										23.3	21.9	165
170										21.9	21	170
175										20.8	20.2	175
180											19.3	180
185											17.5	185
190											13.3	190
%	I	0	0/ 0	46/ 0/ 0	92/46/ 0	92/46/ 0	92/46/ 0	92/46/ 0	92/46	92	100	I
	II	0	46/ 0	46/ 0/ 0	46/46/46	46/46/92	46/92/92	92/92/92	92/92	92	100	II
	III	0	0/ 0	0/46/ 0	0/46/46	46/46/46	46/46/92	46/92/92	92/92	92	100	III
	IV	0	0/46	0/46/92	0/ 0/46	0/46/46	46/46/46	46/46/92	46/92	92	100	IV

* over rear / en arrière

TAB 122363 / 122364

Lifting capacities are given in kips. (1,000 lbs).

Lifting capacities on telescopic boom. Forces de levage à la flèche télescopique.

LTM 1300/1



49 ft – 197 ft

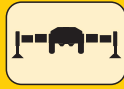

29' x 27'11"



360°



247500 lbs

85%

ft	49 ft	66 ft	83 ft	100 ft	117 ft	134 ft	151 ft	168 ft	185 ft	197 ft	ft
14			368								14
15	389	368	364								15
16	373	367	351								16
17	359	359	339	290							17
18	346	345	328	282							18
20	320	320	306	266	216						20
22	297	297	288	252	206						22
24	277	277	270	239	196	172					24
26	258	258	254	226	187	165					26
28	243	243	240	215	179	159	137				28
30	228	228	226	204	171	153	132	112			30
32	216	215	213	194	164	147	127	109			32
34	204	204	202	186	158	141	123	106	88.5		34
36	194	194	192	177	152	136	119	103	86.5		36
38	184	183	181	169	146	131	115	100	84.5		38
40		174	172	161	140	126	111	97.5	82.5	73.5	40
45		153	152	146	128	115	102	90.5	78	71	45
50		137	135	133	118	105	93.5	84	73.5	67	50
55		123	121	121	109	97	86.5	78	69.5	63.5	55
60			109	111	101	90	80	72.5	65	60.5	60
65			99	101	93.5	84	74	67.5	61.5	57.3	65
70			91	92.5	87.5	78.5	69.5	63	58.2	54.2	70
75				85	82	73.5	65	59.2	55	51.2	75
80				78.5	77	68.5	61	55.8	51.9	48.3	80
85				73	72	64.5	57.1	52.6	49.1	45.7	85
90				68	68.5	60.5	54.1	49.6	46.4	43.4	90
95					64.5	56.9	51.2	46.7	43.9	41.2	95
100					61	53.5	48.5	44.1	41.6	39.1	100
105						50.8	45.9	41.9	39.3	37.1	105
110						48.2	43.4	39.8	37.5	35.3	110
115						45.8	41.3	37.9	35.8	33.6	115
120						43.8	39.3	36	34.1	32.2	120
125							37.4	34.2	32.5	30.7	125
130							35.7	32.8	31	29.4	130
135							34.3	31.5	29.5	28.1	135
140							31.9	30.1	28.2	26.8	140
145								28.7	27.2	25.6	145
150								27.4	26.2	24.4	150
155								26.4	25.3	23.6	155
160									24.3	22.7	160
165									23.4	21.9	165
170									22.4	21	170
175									21.4	20.2	175
180										19.4	180
185										17.6	185
190										13.3	190
I	0	0/ 0	46/ 0/ 0	92/46/ 0	92/46/ 0	92/46/ 0	92/46/ 0	92/46	92	100	I
II	0	46/ 0	46/ 0/ 0	46/46/46	46/46/92	46/92/92	92/92/92	92/92	92	100	II
III	0	0/ 0	0/46/ 0	0/46/46	46/46/46	46/46/92	46/92/92	92/92	92	100	III
IV	0	0/46	0/46/92	0/ 0/46	0/46/46	46/46/46	46/46/92	46/92	92	100	IV

TAB 122362

Les forces de levage sont données en kips. (1,000 lbs).

Lifting heights. Hauteurs de levage.

LTM 1300/1

Telescopic boom.
Flèche télescopique.

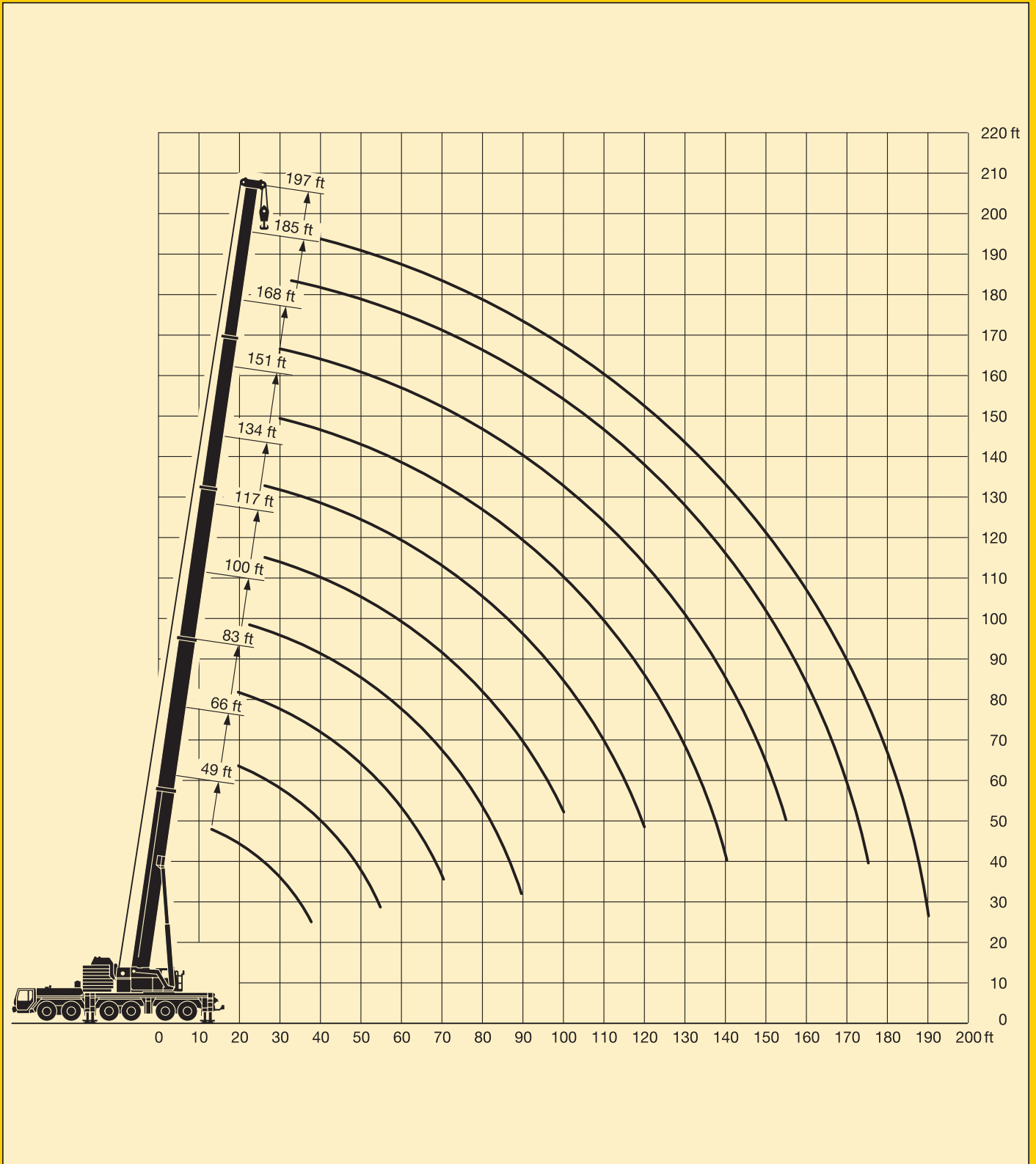

Lifting capacities on guyed telescopic boom. Forces de levage à la flèche télescopique haubanée.

LTM 1300/1



100 ft – 197 ft

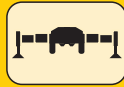

29' x 27'11"



360°



247500 lbs

85%

ft	100 ft	117 ft	134 ft	151 ft	168 ft	185 ft	197 ft	ft
24	267	223	183					24
26	254	219	180					26
28	241	216	178	143				28
30	228	212	175	142	115			30
32	215	208	173	140	114			32
34	204	201	171	138	113	92.5		34
36	193	191	168	137	111	92		36
38	183	181	165	135	110	91		38
40	173	172	162	133	109	90.5	75	40
45	153	155	154	129	106	88.5	75	45
50	137	140	140	125	104	86.5	74.5	50
55	122	125	126	119	101	84.5	73.5	55
60	110	113	114	114	98	83	72.5	60
65	99.5	102	103	104	95	81	71	65
70	90.5	93.5	94.5	95.5	92	79	69.5	70
75	83	86	86.5	88	86.5	77	68	75
80	76	79	79.5	81	81	75.5	66.5	80
85	69.5	72.5	73	74.5	76.5	73.5	65	85
90	64	67	67.5	69	71	69	63.5	90
95		62	62.5	64	66	64.5	62.5	95
100		57.5	58	59.4	61.5	59.9	59.9	100
105			53.9	55.3	57.3	55.7	55.8	105
110			50.2	51.6	53.7	52.1	52.1	110
115			46.8	48.2	50.3	48.7	48.8	115
120			43.7	45.1	47.1	45.5	45.6	120
125				42.2	44.2	42.6	42.7	125
130				39.5	41.6	40	40.1	130
135				37.1	39.1	37.5	37.6	135
140				31.9	36.8	35.2	35.4	140
145					34.6	33.1	33.2	145
150					32.6	31.1	31.2	150
155					30.8	29.2	29.3	155
160						27.4	27.5	160
165						25.7	25.8	165
170						24.1	24.2	170
175							22.8	175
180							21.4	180
I	46	92/46/ 0	92/46	92/46/ 0	92/46	92	100	I
II	46	46/46/ 0	46/92	92/92/92	92/92	92	100	II
III	46	46/46/92	46/46	46/92/92	92/92	92	100	III
IV	0	0/46/92	46/46	46/46/92	46/92	92	100	IV

TAB 122365

Remarks referring to load charts.

- When calculating crane stresses and loads, German Industrial Standards (DIN) are applicable, in conformity with German legislation (published 2/85): The lifting capacities (stability margin) DIN/ISO are as laid down in DIN 15019, part 2, and ISO 4305. The crane's structural steel works is in accordance with DIN 15018, part 3. Design and construction of the crane comply with DIN 15018, part 2, and with F. E. M. regulations.
- For the DIN/ISO load charts, depending on jib length, crane operation may be permissible at wind speeds up to 5 resp. 7 Beaufort.
- Lifting capacities are given in kips.
- The weight of the hook blocks and hooks must be deducted from the lifting capacities.
- Working radii are measured from the slewing centreline.
- Subject to modification of lifting capacities.
- Lifting capacities above 367 kips only with special equipments.

Remarques relatives aux tableaux des charges.

- La grue est calculée selon normes DIN conformément au décret fédéral 2/85. Les charges DIN/ISO respectent les sécurités au basculement requises par les normes DIN 15019, partie 2 et ISO 4305. La structure de la grue est conçue selon la norme DIN 15018, partie 3. La conception générale est réalisée selon la norme DIN 15018, partie 2, ainsi que selon les recommandations de la F. E. M.
- Les charges DIN/ISO tiennent compte d'efforts au vent selon Beaufort de 5 à 7 en fonction de la longueur de flèche.
- Les charges sont indiquées en kips.
- Les poids du crochet ou de la moufle sont à déduire des charges indiquées.
- Les portées sont prises à partir de l'axe de rotation de la partie tournante.
- Charges données sous réserve de modification.
- Forces de levage plus de 367 kips seulement avec équipements supplémentaires.

Lifting capacities on guyed telescopic boom. Forces de levage à la flèche télescopique haubanée.

LTM 1300/1



100 ft – 197 ft

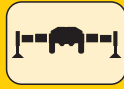

29' x 27'11"



360°



192500 lbs

85%

ft	100 ft	117 ft	134 ft	151 ft	168 ft	185 ft	197 ft	ft
17	303							17
18	300							18
20	292	232						20
22	280	227						22
24	266	223	183					24
26	250	219	180					26
28	234	216	178	143				28
30	219	211	175	142	115			30
32	206	203	173	140	114			32
34	195	193	171	138	113	92.5		34
36	184	183	168	137	111	92		36
38	173	172	165	135	110	91		38
40	163	166	161	133	109	90.5	75	40
45	142	145	145	129	106	88.5	75	45
50	126	129	130	124	104	86.5	74.5	50
55	112	115	116	116	101	84.5	73.5	55
60	101	104	104	106	97.5	83	72.5	60
65	91	94	94.5	96	93.5	81	71	65
70	82	85.5	86	87.5	87.5	79	69.5	70
75	74.5	77.5	78.5	79.5	82	76.5	68	75
80	67.5	71	71.5	72.5	75	73	66.5	80
85	61.5	64.5	65	66.5	69	67	65	85
90	56.2	59.4	59.9	61.5	63.5	62	61.5	90
95		57.1	55.2	56.6	58.8	57.1	57.1	95
100		55.2	50.9	52.3	54.4	52.7	52.8	100
105			46.9	48.3	50.5	48.8	48.9	105
110			43.5	44.9	47	45.3	45.4	110
115			40.3	41.7	43.8	42.2	42.2	115
120			37.4	40.5	40.9	39.2	39.3	120
125				38.7	38.1	36.5	36.5	125
130				36.2	35.6	34	34.1	130
135				33.9	33.3	31.7	31.8	135
140				30.7	31.2	29.6	29.6	140
145					29.2	27.6	27.7	145
150					27.3	25.7	25.8	150
155					25.6	24	24.1	155
160						22.4	22.5	160
165						20.8	20.9	165
170						19.4	19.5	170
175							18.1	175
180							16.8	180
I	46	92/46/ 0	92/46	92/46/ 0	92/46	92	100	I
II	46	46/46/ 0	46/92	92/92/92	92/92	92	100	II
III	46	46/46/92	46/46	46/92/92	92/92	92	100	III
IV	0	0/46/92	46/46	46/46/92	46/92	92	100	IV

TAB 122353

Lifting heights. Hauteurs de levage.

LTM 1300/1

Guyed telescopic boom.
Flèche télescopique haubanée.

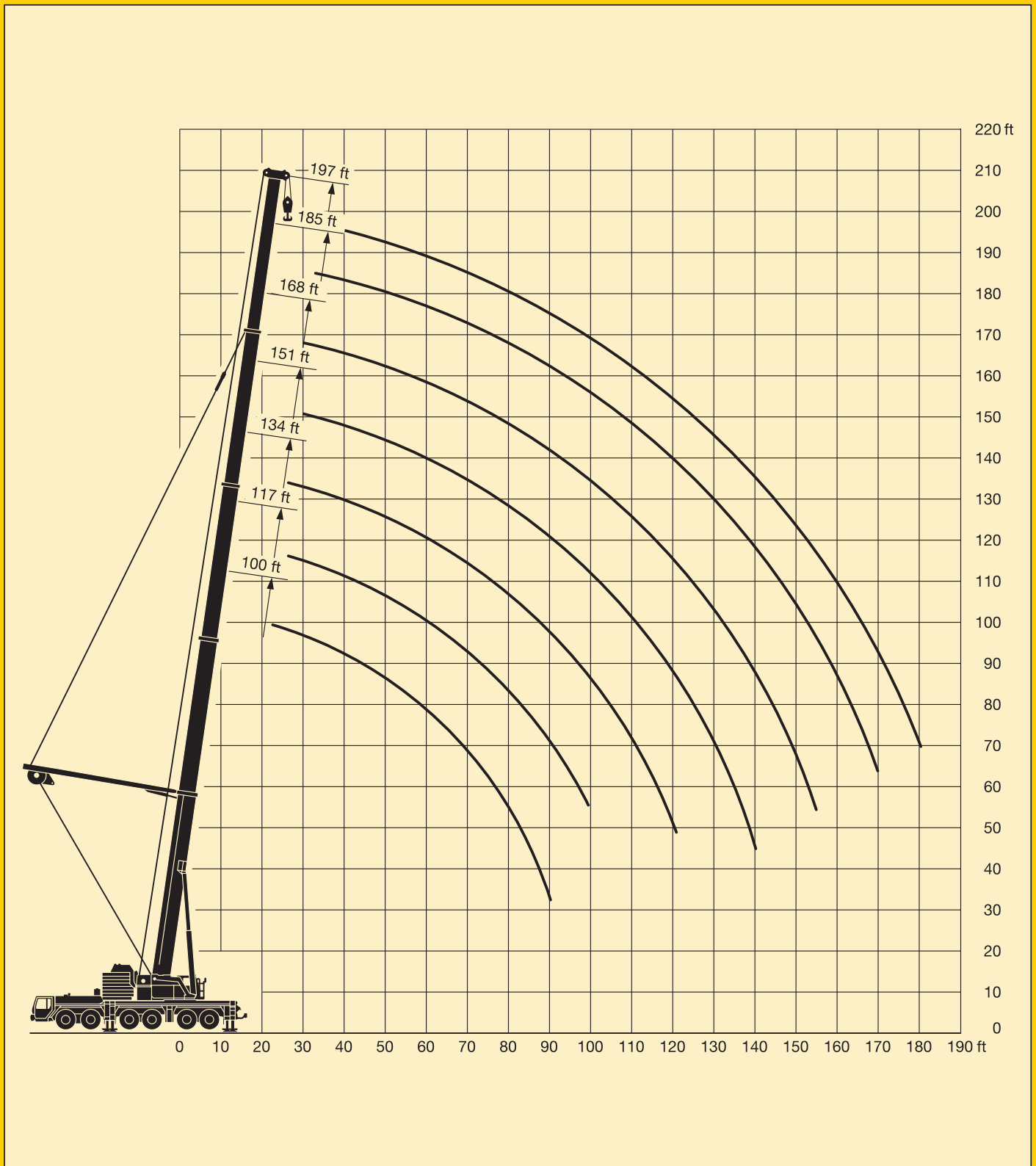

Lifting capacities on the folding jib. Forces de levage à la fléchette pliante.

LTM 1300/1



49 ft – 197 ft

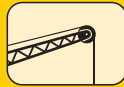

40 ft



29' x 27'11"



360°



192500 lbs

85%

ft	49 ft			151 ft			168 ft			185 ft			197 ft			ft
	40 ft			40 ft			40 ft			40 ft			40 ft			
	0°	20°	40°	0°	20°	40°	0°	20°	40°	0°	20°	40°	0°	20°	40°	
12	50.9															12
13	50.9															13
14	50.9															14
15	50.9															15
16	50.9															16
17	50.9															17
18	50.9															18
20	50.9															20
22	50.9															22
24	50.9	43.1														24
26	50.9	41.3														26
28	50.5	39.8														28
30	49.7	38.3														30
32	48.3	36.9														32
34	46.7	35.7	28.2	50.9												34
36	44.9	34.6	27.5	50.9												36
38	43.2	33.5	26.9	50.9												38
40	41.5	32.4	26.3	50.9			50.9									40
45	38	30.2	25.1	50.9			50.9									45
50	34.8	28.3	24.1	50.9	40.5		50.9			47.4			43.6			50
55	31.6	26.7	23.3	50.9	38.8	28	50.9	38.1		45.5			42.1			55
60	28.6	25.4	22.7	50.9	37.2	27.3	50.6	36.7	27.1	43.7	35.4		40.6	34.6		60
65	26.2	24.1	22.3	50.9	35.8	26.7	49	35.4	26.5	41.8	34.3		39.2	33.6		65
70	24	23.7	22.2	49.6	34.4	26.1	47.4	34.2	26	39.9	33.3	25.7	37.6	32.6	25.4	70
75	21.8	22.5		48	33.2	25.5	45.8	33.1	25.5	38.1	32.3	25.2	36	31.8	25	75
80				46	32.2	25	44	32.1	25	36.5	31.4	24.8	34.5	30.9	24.6	80
85				43.7	31.1	24.6	41.8	31.1	24.6	34.9	30.6	24.4	33.2	30.2	24.2	85
90				41.9	30.2	24.2	39.8	30.3	24.2	33.5	29.8	24	31.9	29.2	23.9	90
95				40.2	29.3	23.9	38	29.5	23.9	32.1	28.9	23.7	30.7	28.2	23.6	95
100				38.5	28.4	23.5	36.3	28.7	23.6	30.8	28	23.5	29.5	27.2	23.3	100
105				37	27.6	23.2	34.7	28	23.3	29.7	27.2	23.2	28.3	26.3	23	105
110				35.5	27	23	33.2	27.3	23	28.5	26.4	23	27.3	25.4	22.8	110
115				34.1	26.4	22.8	31.6	26.7	22.8	27.5	25.6	22.7	26.2	24.6	22.6	115
120				32.7	25.8	22.6	30	26.2	22.7	26.5	24.8	22.5	25.2	23.9	22.4	120
125				31.3	25.3	22.4	28.5	25.7	22.5	25.5	24.1	22.3	24.2	23.2	22.2	125
130				29.7	24.8	22.3	27.1	25.2	22.4	24.5	23.4	22.1	23.3	22.4	21.9	130
135				28.4	24.3	22.2	25.7	24.8	22.2	23.6	22.7	21.8	22.2	21.8	21.3	135
140				27.3	23.9	22.2	24.5	24.3	22.1	22.6	22.1	21.4	21.2	21.2	20.8	140
145				26.2	23.8	22.2	23.5	23.6	21.9	21.8	21.4	21.1	20.2	20.5	20.3	145
150				25.2	23.7	22.2	22.5	22.5	21.7	20.8	20.7	20.5	19.3	19.7	19.8	150
155				24.2	23.6	22.2	21.6	21.6	21.4	19.9	20	20	18.4	18.8	19.2	155
160				23	23	22.2	20.7	20.7	20.9	19	19.3	19.4	17.6	18	18.4	160
165				21.6	22		19.8	19.8	20	18.2	18.5	18.7	16.8	17.2	17.5	165
170				20.3	20.8		19	19	19.2	17.3	17.7	17.9	16	16.4	16.7	170
175				19	19.4		18.2	18.3	18.3	16.5	17	17.1	15.3	15.7	16	175
180							17.4	17.5		15.8	16.3	16.3	14.6	15	15.2	180
185							16.6	16.7		15.2	15.6	15.7	13.9	14.3	14.5	185
190							15.5	15.9		14.6	14.9	15	13.4	13.6	13.9	190
195							14.3			14	14.2		12.8	12.9	13.2	195
200										13.5	13.6		12.3	12.3	12.5	200
205										12.9	13		11.7	11.7		205
210													11.2	11.2		210
215													10.7	10.6		215
220													10.1			220
I	0			92/ 0			92/46			92			100			I
II	0			92/92			92/92			92			100			II
III	0			46/92			92/92			92			100			III
IV	0			46/92			46/92			92			100			IV

TAB 122357 / 122358 / 122359

Lifting capacities on the folding jib. Forces de levage à la fléchette pliante.

LTM 1300/1



49 ft – 197 ft

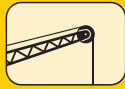

69 ft



29' x 27'11"



360°



192500 lbs



85%

ft	49 ft			151 ft			168 ft			185 ft			197 ft			ft
	69 ft			69 ft			69 ft			69 ft			69 ft			
	0°	20°	40°	0°	20°	40°	0°	20°	40°	0°	20°	40°	0°	20°	40°	
17	25.7															17
18	25.7															18
20	25.7															20
22	25.7															22
24	25.7															24
26	25.7															26
28	25.7															28
30	25.7															30
32	25.7															32
34	25.5															34
36	25															36
38	24.6															38
40	24.1	20.8		25.7			25.7									40
45	22.7	19.6		25.7			25.7									45
50	21.4	18.5		25.7			25.7			25.2						50
55	20.1	17.6		25.7			25.7			24.8			23.6			55
60	19	16.7	14.6	25.7	20.9		25.7			24.3			23.2			60
65	18	15.9	14.1	25.7	20.2		25.4			23.9			22.8			65
70	17.1	15	13.4	25.4	19.6		24.8	19.2		23.3			22.4			70
75	16.1	14.3	12.9	24.7	19		24	18.7		22.6	18.1		21.8			75
80	15.1	13.6	12.4	23.9	18.5	14.8	23.3	18.2		22	17.6		21.3	17.3		80
85	14.4	13	12	23.1	18	14.5	22.6	17.8		21.4	17.2		20.8	16.9		85
90	13.7	12.4	11.7	22.3	17.5	14.3	21.9	17.3	14.2	20.9	16.9		20.3	16.5		90
95	13	11.8	11.5	21.6	17	14	21.3	16.9	13.9	20.4	16.5	13.7	19.9	16.2	13.6	95
100	12.4	11.5	11	20.9	16.6	13.7	20.7	16.5	13.7	19.9	16.1	13.5	19.4	15.9	13.4	100
105	11.8			20.3	16.3	13.4	20.1	16.2	13.4	19.4	15.8	13.3	18.9	15.5	13.2	105
110	11.3			19.7	15.9	13.1	19.5	15.8	13.2	19	15.5	13	18.5	15.3	12.9	110
115				19.1	15.4	12.9	19	15.5	12.9	18.5	15.2	12.8	18.1	15	12.7	115
120				18.6	14.9	12.7	18.5	15.1	12.7	18	14.9	12.6	17.7	14.7	12.5	120
125				18	14.5	12.4	18	14.8	12.5	17.6	14.6	12.4	17.3	14.5	12.4	125
130				17.5	14.2	12.3	17.6	14.4	12.3	17.2	14.3	12.3	16.9	14.2	12.2	130
135				17	13.8	12.1	17.1	14	12.2	16.8	13.9	12.1	16.6	13.9	12.1	135
140				16.5	13.5	11.9	16.7	13.7	12	16.4	13.6	12	16.2	13.6	11.9	140
145				16	13.2	11.8	16.3	13.3	11.8	16.1	13.3	11.8	15.8	13.3	11.8	145
150				15.4	12.9	11.7	15.9	13.1	11.7	15.7	13.1	11.7	15.3	13.1	11.7	150
155				14.9	12.7	11.6	15.4	12.9	11.6	15.3	12.9	11.6	14.8	12.8	11.6	155
160				14.5	12.4	11.5	14.9	12.6	11.6	14.9	12.7	11.5	14.4	12.6	11.5	160
165				14.2	12.1	11.5	14.5	12.4	11.5	14.5	12.5	11.5	13.9	12.4	11.4	165
170				13.8	11.9	11.4	14.2	12.2	11.5	14.1	12.3	11.4	13.5	12.2	11.3	170
175				13.5	11.6	11.4	13.8	12	11.5	13.7	12.1	11.4	13.1	12	11.3	175
180				13.1	11.5	11.4	13.4	11.8	11.4	13.3	12	11.4	12.7	11.9	11.3	180
185				12.8	11.4	11.4	13.1	11.6	11.4	12.8	11.8	11.4	12.3	11.7	11.3	185
190				12.5	11.4	11.4	12.8	11.4	11.4	12.5	11.6	11.4	11.7	11.6	11.3	190
195				12.2	11.4		12.5	11.4	11.4	12.2	11.4	11.4	11.2	11.3	11.3	195
200				11.9	11.4		12.2	11.4	11.4	11.8	11.4	11.4	10.6	11	11.2	200
205							12	11.4		11.3	11.3	11.4	10.1	10.7	11	205
210							11.8	11.4		10.9	11.1	11.4	9.6	10.1	10.7	210
215							11.3	11.4		10.5	10.7	10.9	9.2	9.8	10.1	215
220							10.7			10	10.2	10.4	8.9	9.4	9.6	220
225										9.6	9.7		8.5	9	9.1	225
230										9.1	9.3		8.2	8.5		230
235										8.7	8.8		7.8	8.1		235
240													7.5	7.8		240
245													7.1	7.4		245
I	0			92/ 0			92/46			92			100			I
II	0			92/92			92/92			92			100			II
III	0			46/92			92/92			92			100			III
IV	0			46/92			46/92			92			100			IV

TAB 122357 / 122358 / 122359

Lifting heights. Hauteurs de levage.

LTM 1300/1

Folding jib.
Fléchette pliante.

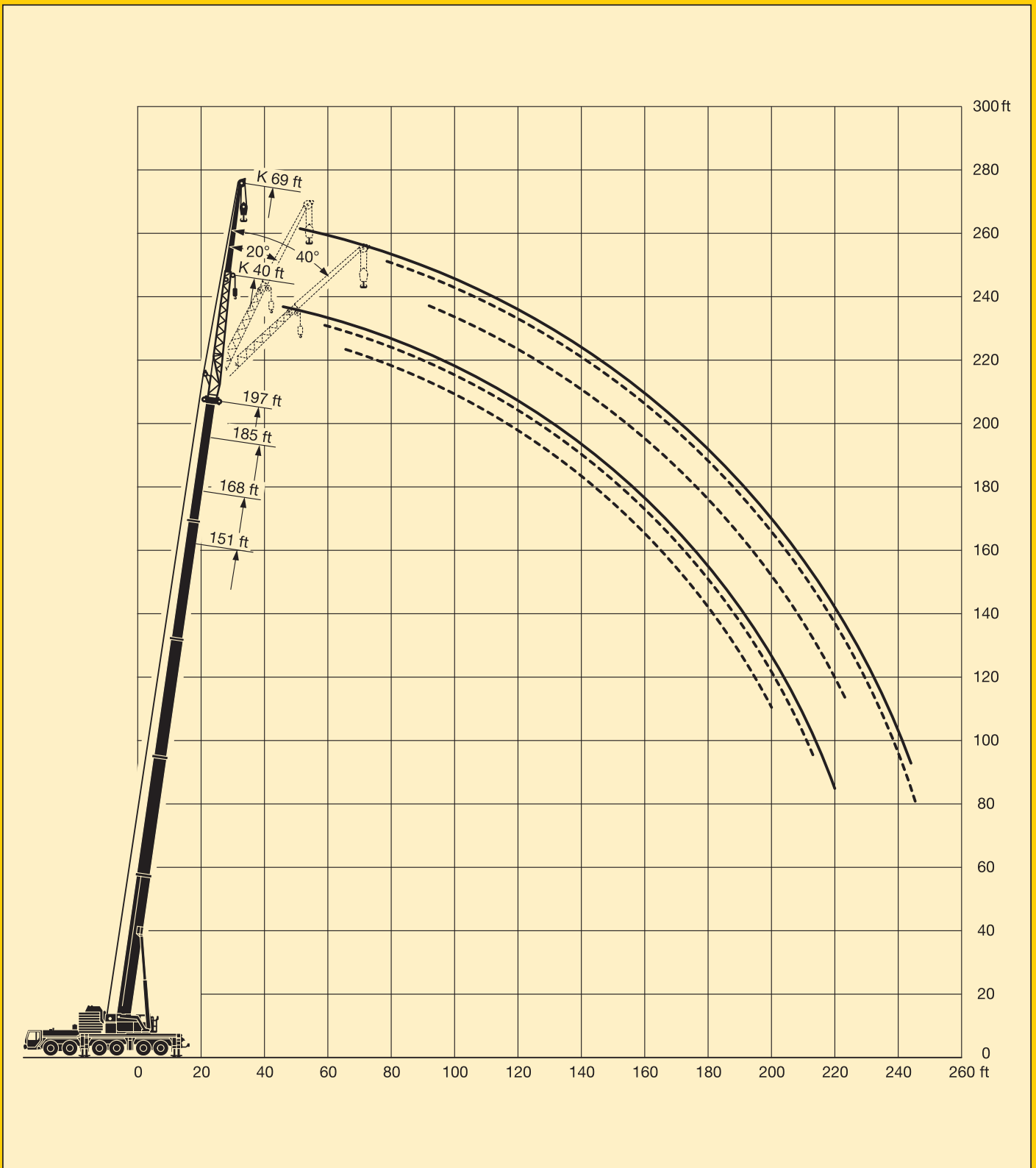

Lifting capacities on the folding jib with guyed telescopic boom.

LTM 1300/1

Forces de levage à la fléchette pliante avec flèche télescopique haubanée.



168 ft – 197 ft

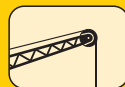

40 ft – 69 ft



29' x 27'11"



360°



247500 lbs

85%

ft	168 ft			185 ft			197 ft			168 ft			185 ft			197 ft			ft
	40 ft			40 ft			40 ft			69 ft			69 ft			69 ft			
	0°	20°	40°	0°	20°	40°	0°	20°	40°	0°	20°	40°	0°	20°	40°	0°	20°	40°	
40	50.9									25.7									40
45	50.9									25.7									45
50	50.9			48.2			42.4			25.7			25.3					23.6	50
55	50.9	40.7		47.4	39.6		41.7			25.7			24.9					23.6	55
60	50.9	39.1	27.8	46.5	38.2		41	37.2		25.7			24.5					23.2	60
65	50.9	37.7	27.2	45.5	37		40.3	36.1		25.7			24.2					22.9	65
70	50.9	36.4	26.6	44.5	35.9	26.5	39.6	35.1	26.3	25.3	19.6		23.7					22.6	70
75	50.2	35.2	26.1	43.7	34.9	26	38.8	34.2	25.9	24.7	19.1		23.2	18.6				22.2	75
80	49	34.1	25.6	42.8	33.8	25.6	38.1	33.3	25.4	24.1	18.7		22.7	18.2				21.8	80
85	47.8	33	25.2	42.1	32.9	25.2	37.3	32.5	25.1	23.4	18.2		22.1	17.8				21.4	85
90	46.4	32.1	24.8	41.3	32	24.8	36.6	31.6	24.7	22.8	17.8	14.3	21.6	17.4				21	90
95	44.8	31.2	24.4	40.6	31.2	24.4	35.9	30.9	24.3	22.2	17.4	14.1	21.1	17.1	13.9	20.6	16.7	13.7	95
100	43	30.3	24	39.9	30.4	24.1	35.1	30.1	24	21.7	17	13.9	20.7	16.8	13.7	20.1	16.4	13.6	100
105	41.3	29.5	23.7	39.1	29.6	23.8	34.4	29.4	23.7	21.1	16.6	13.7	20.3	16.4	13.6	19.7	16.1	13.4	105
110	39.8	28.7	23.3	38.4	28.9	23.5	33.7	28.8	23.4	20.5	16.3	13.5	19.8	16.1	13.4	19.2	15.8	13.2	110
115	38.3	28	23	37.5	28.3	23.2	33.1	28.2	23.1	19.9	16	13.4	19.4	15.8	13.3	18.8	15.5	13.1	115
120	36.8	27.4	22.8	36.4	27.7	22.9	32.5	27.6	22.9	19.4	15.6	13.2	18.9	15.5	13.1	18.4	15.2	13	120
125	35.4	26.8	22.6	35.3	27.1	22.7	31.8	27	22.6	18.9	15.3	13.1	18.5	15.2	13	18	15	12.9	125
130	34.1	26.2	22.4	34.3	26.6	22.5	31.3	26.5	22.4	18.4	15	12.9	18	14.9	12.8	17.6	14.7	12.7	130
135	32.8	25.7	22.2	33.3	26.1	22.3	30.7	26	22.3	17.9	14.8	12.8	17.6	14.7	12.7	17.3	14.5	12.6	135
140	31.7	25.2	22	32.3	25.6	22.2	30.1	25.5	22.1	17.5	14.5	12.6	17.2	14.4	12.6	16.9	14.2	12.5	140
145	30.7	24.7	22	31.4	25.1	22	29.6	25.1	21.9	17	14.2	12.4	16.9	14.1	12.6	16.6	14	12.4	145
150	29.5	24.3	22	30.3	24.6	21.8	29.1	24.7	21.8	16.6	14	12.2	16.5	14	12.4	16.2	13.8	12.3	150
155	28.5	24	21.9	28.6	24.3	21.8	28.1	24.3	21.7	16.2	13.9	12.1	16.1	13.8	12.3	15.9	13.6	12.3	155
160	27.7	23.6	21.9	26.9	24	21.8	26.6	24	21.6	15.8	13.7	12.1	15.8	13.7	12.2	15.6	13.4	12.2	160
165	26.7	23.3	21.8	25.2	23.7	21.8	25	23.7	21.6	15.5	13.5	12	15.4	13.5	12.1	15.3	13.3	12.1	165
170	25.3	23	21.8	23.6	23.4	21.8	23.4	23.4	21.6	15.2	13.3	11.9	15.1	13.3	12	15	13.1	12	170
175	23.9	22.6	21.8	22.1	22.7	21.8	21.9	22.6	21.6	14.9	13.2	11.8	14.9	13.2	11.9	14.7	13	11.9	175
180	22.5	22.3		20.7	21.6	21.4	20.5	21.5	21.3	14.6	13	11.8	14.7	13	11.8	14.5	12.9	11.9	180
185	21.2	21.7		19.4	20.2	20.5	19.2	20.1	20.5	14.3	12.9	11.8	14.4	12.9	11.8	14.3	12.7	11.8	185
190	19.9	20.3		18.1	18.8	19.1	17.9	18.7	19.1	14.1	12.9	11.8	14.2	12.8	11.8	14.1	12.7	11.8	190
195				16.9	17.5		16.7	17.4	17.8	13.8	12.8	11.8	14	12.8	11.8	14	12.6	11.7	195
200				15.8	16.3		15.5	16.2	16.5	13.7	12.7	11.8	13.8	12.8	11.8	13.8	12.6	11.7	200
205				14.7	15.1		14.4	15		13.5	12.6		13.6	12.7	11.8	13.6	12.5	11.7	205
210							13.4	13.9		13.4	12.4		13.4	12.7	11.8	13.4	12.4	11.7	210
215							12.4	12.8		13.2	12.4		13.3	12.6	11.8	13.3	12.4	11.7	215
220							11.4			13			12.8	12.5	11.8	12.7	12.4	11.7	220
225													12.1	12.3		11.7	12.3	11.7	225
230													11.1	11.9		10.8	11.8		230
235													10.3	10.9		10	10.8		235
240																9.3	9.9		240
245																8.8	9.2		245
I	92/46			92			100			92/46			92			100			I
II	92/92			92			100			92/92			92			100			II
III	92/92			92			100			92/92			92			100			III
IV	46/92			92			100			46/92			92			100			IV

TAB 122369 / 122370 / 122371

Lifting heights. Hauteurs de levage.

LTM 1300/1

Folding jib on guyed telescopic boom.
Fléchette pliante à la flèche télescopique haubanée.

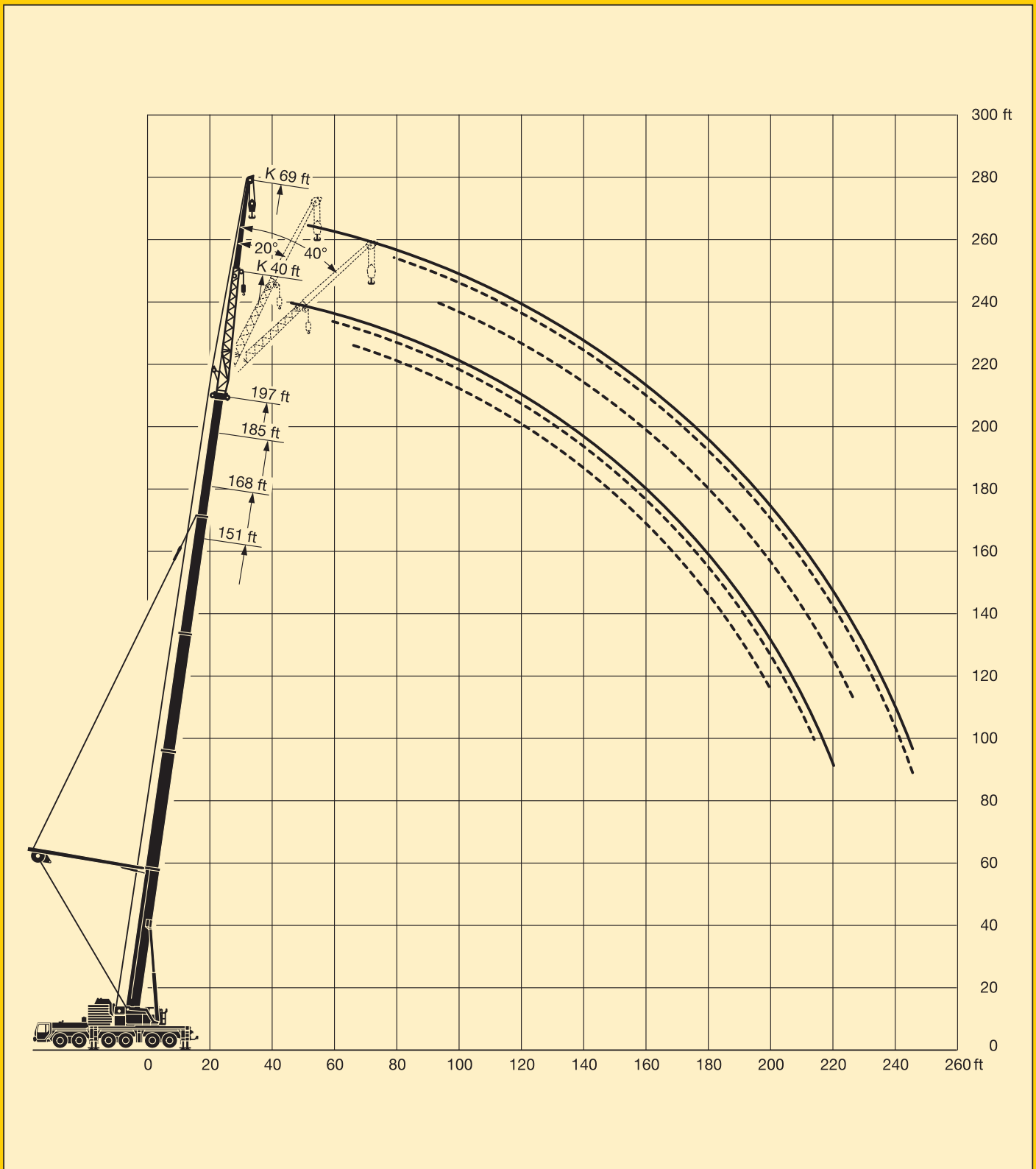

Lifting capacities on the lattice fly jib. Forces de levage à la fléchette treillis fixe.

LTM 1300/1



151 ft – 197 ft



0°
46 ft – 161 ft



29' x 27'11"



360°



192500 lbs

85%

ft	151 ft + 8 ft*	168 ft + 8 ft*	185 ft + 8 ft*					197 ft + 8 ft*	ft
	46 ft	46 ft	46 ft	69 ft	92 ft	115 ft	138 ft	138 ft	
40	61.5								40
45	58.9								45
50	56.1	49.3	38.1						50
55	53.4	47.2	36.5	28.2					55
60	50.8	45	35	27	21.6				60
65	48.3	43.1	33.6	25.9	20.7				65
70	46	41	32	24.9	19.9	15.6			70
75	43.8	39	30.6	23.8	19	14.9	11.4		75
80	41.7	37.1	29.2	22.7	18	14.1	10.7	9.6	80
85	40	35.3	27.9	21.6	17.2	13.3	10.1	9.4	85
90	38.3	33.6	26.8	20.6	16.3	12.6	9.5	8.9	90
95	36.8	32.2	25.6	19.6	15.6	11.9	8.9	8.4	95
100	35.2	30.8	24.6	18.8	14.8	11.3	8.4	8	100
105	33.5	29.4	23.5	18	14.1	10.7	8	7.7	105
110	31.5	28	22.6	17.2	13.5	10.1	7.7	7.3	110
115	29.9	26.7	21.6	16.5	12.8	9.6	7.3	7	115
120	28.4	25.4	20.8	15.8	12.2	9.1	7	6.7	120
125	26.9	24.1	19.9	15.2	11.7	8.6	6.7	6.4	125
130	25.6	22.9	19.1	14.5	11.2	8.3	6.3	6.1	130
135	24.3	21.7	18.4	14	10.7	7.9	6.1	5.9	135
140	23	20.6	17.7	13.4	10.2	7.6	5.8	5.6	140
145	21.7	19.5	17	12.9	9.8	7.3	5.5	5.4	145
150	20.5	18.4	16.4	12.5	9.3	7	5.3	5.1	150
155	19.6	17.4	15.7	12	9	6.7	5	4.9	155
160	18.7	16.4	14.9	11.5	8.7	6.5	4.8	4.7	160
165	17.8	15.5	14.1	11.1	8.4	6.2			165
170	17	14.7	13.3	10.6	8.1	6			170
175	16.2	14	12.5	10.2	7.9	5.8			175
180	15.2	13.3	11.8	9.9	7.6	5.5			180
185	14	12.6	11.1	9.6	7.3	5.3			185
190	12.9	11.9	10.4	9.2	7.1	5.1			190
195		11.3	9.8	8.8	6.9	4.9			195
200		10.5	9.3	8.3	6.7	4.7			200
205			8.9	7.8	6.5	4.5			205
210			8.5	7.3	6.3	4.4			210
215			8.1	6.9	6.1	4.2			215
220			7.7	6.6	5.9	4.1			220
225				6.3	5.7	4			225
230				6	5.3	3.8			230
235				5.6	5.1	3.7			235
240				5.3	4.8	3.5			240
245					4.5	3.4			245
250					4.2	3.3			250
255					3.9	3			255
260					3.7	2.8			260
265					3.4				265
I	92	92	92	92	92	92	92	100	I
II	92	92	92	92	92	92	92	100	II
III	46	92	92	92	92	92	92	100	III
IV	46	46	92	92	92	92	92	100	IV

* adapter / pièce d'adaptateur

TAB 122372

Lifting capacities on the lattice fly jib. Forces de levage à la fléchette treillis fixe.

LTM 1300/1



151 ft – 197 ft

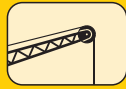

20° / 40°
46 ft – 138 ft



29' x 27'11"



360°



192500 lbs

85%

ft	151 ft + 8 ft*		168 ft + 8 ft*		185 ft + 8 ft*								ft
	46 ft		46 ft		46 ft		69 ft		92 ft		115 ft		
	20°	40°	20°	40°	20°	40°	20°	40°	20°	40°	20°	40°	
60	41.5		39.9										60
65	39.8		38.3										65
70	38.2	26.8	36.6		26.8								70
75	36.7	26.3	35	26	25.7								75
80	35.3	25.8	33.4	25.5	24.7	22	18.5						80
85	34	25.3	32	25.1	23.7	21.3	17.7						85
90	32.8	24.9	30.6	24.7	22.8	20.7	17						90
95	31.8	24.4	29.4	24.4	22	20	16.3		12.4				95
100	30.7	24.1	28.3	24	21.3	19.4	15.7	13.8	11.9				100
105	29.8	23.8	27.2	23.7	20.6	18.9	15.1	13.4	11.4		8.3		105
110	28.9	23.6	26.2	23.4	19.9	18.3	14.5	13	10.9		8		110
115	28	23.3	25.2	23.2	19.2	17.8	14	12.6	10.4	8.6	7.7		115
120	27.1	23.1	24.2	23	18.6	17.4	13.5	12.2	10	8.5	7.4		120
125	26.5	22.8	23.3	22.7	18	16.9	13	11.8	9.7	8.4	7.1		125
130	25.8	22.6	22.6	22	17.5	16.5	12.6	11.4	9.3	8.2	6.9		130
135	24.7	22.6	21.8	21.3	17	16.1	12.1	11.1	9	8	6.6	5.2	135
140	23.5	22.6	20.9	20.7	16.5	15.8	11.7	10.8	8.6	7.8	6.4	5.1	140
145	22.3	22.5	20	20.1	16	15.4	11.4	10.5	8.3	7.6	6.1	5	145
150	21.1	21.6	18.9	19.4	15.5	15.1	11	10.2	8.1	7.4	5.9	4.9	150
155	20.1	20.5	17.9	18.4	14.9	14.7	10.6	10	7.8	7.3	5.7	4.8	155
160	19.2	19.5	16.9	17.4	14.5	14.3	10.3	9.7	7.6	7.1	5.5	4.7	160
165	18.3	18.5	15.9	16.5	14	13.9	10	9.5	7.4	6.9	5.3	4.6	165
170	17.4	17.6	15.1	15.6	13.6	13.6	9.7	9.3	7.2	6.7	5.1	4.6	170
175	16.6	16.7	14.4	14.7	13	13.2	9.5	9.1	7	6.6	4.9	4.5	175
180	15.7		13.6	13.9	12.3	12.8	9.3	8.9	6.8	6.4	4.8	4.4	180
185	14.6		12.9	13.1	11.5	12.1	9.1	8.7	6.6	6.3	4.6	4.2	185
190	13.4		12.1	12.3	10.8	11.4	8.8	8.7	6.4	6.2	4.4	4.1	190
195			11.4		10.3	10.7	8.6	8.5	6.3	6	4.3	4	195
200			10.7		9.8	10	8.3	8.4	6.1	5.9	4.1	3.9	200
205					9.2		8.1	8.3	6	5.8	4	3.8	205
210					8.7		7.9	8.1	5.8	5.7	3.9	3.7	210
215					8.2		7.5	7.8	5.7	5.7	3.7	3.6	215
220					7.8		7.1	7.3	5.5	5.6	3.6	3.5	220
225							6.7	6.9	5.4	5.5	3.5	3.4	225
230							6.3		5.4	5.4	3.4	3.3	230
235							6		5.3	5.4	3.3	3.3	235
240							5.6		5.1	5.3	3.2	3.2	240
245									4.9	5.1	3.1	3.1	245
250									4.5		3	3.1	250
255									4.2		3	3	255
260									3.9		2.9	3	260
265									3.6		2.9	3	265
I	92		92		92		92		92		92		I
II	92		92		92		92		92		92		II
III	46		92		92		92		92		92		III
% IV	46		46		92		92		92		92		IV

* adapter / pièce d'adaptateur

TAB 122373 / 122374

Lifting heights. Hauteurs de levage.

LTM 1300/1

Lattice fly jib.
Fléchette treillis fixe.

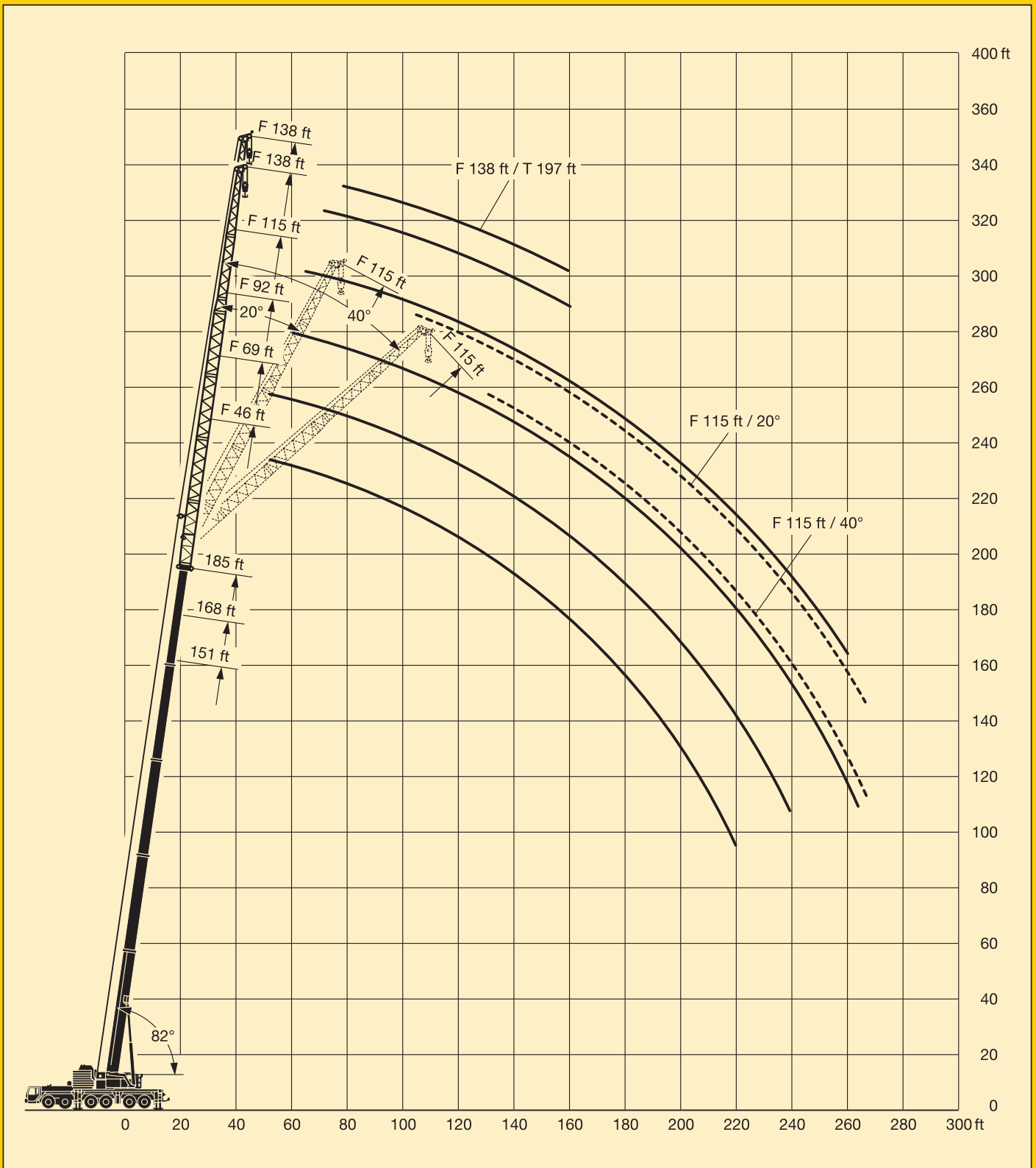

Lifting capacities on the lattice fly jib with guyed telescopic boom.

LTM 1300/1

Forces de levage à la fléchette treillis fixe avec flèche télescopique haubanée.



151 ft – 197 ft



0°
46 ft – 161 ft



29' x 27'11"



360°



247500 lbs



85%

ft	151 ft + 8 ft*		168 ft + 8 ft*		185 ft + 8 ft*				197 ft + 8 ft*		ft
	46 ft	46 ft	46 ft	69 ft	92 ft	115 ft	138 ft	161 ft	138 ft	161 ft	
40	68										40
45	68										45
50	66.5	54.6	40.9								50
55	64.5	54	40.5	32.6							55
60	62	53.2	39.9	32.2	24.9						60
65	59.9	52.3	39.2	31.6	24.8						65
70	58	51.5	38.6	30.8	24.4	19.6					70
75	56.1	50.5	38	30	24	19.2	14.6				75
80	54.3	49.5	37.4	29.3	23.4	18.7	14.5	9.7	12.1		80
85	52.5	48.6	36.7	28.6	22.7	18.1	14.1	9.7	12.1		85
90	50.8	47.5	35.9	27.8	22.1	17.5	13.7	9.6	12	8	90
95	49.2	46.5	35.1	27	21.6	17	13.2	9.3	11.7	8	95
100	47.6	45.5	34.2	26.2	21.1	16.5	12.7	9	11.3	7.9	100
105	46.2	44.6	33.5	25.5	20.6	16	12.2	8.7	10.9	7.7	105
110	44.8	43.6	32.7	24.9	20	15.5	11.8	8.4	10.6	7.4	110
115	43.6	42.6	32	24.2	19.4	15.1	11.3	8.1	10.2	7.2	115
120	41.7	41.2	31.3	23.6	18.9	14.6	10.9	7.8	9.9	6.9	120
125	38.8	38.9	30.6	23	18.4	14.1	10.5	7.6	9.5	6.7	125
130	36.2	36.3	30	22.4	17.9	13.7	10.1	7.3	9.2	6.5	130
135	33.7	33.8	29.3	21.8	17.4	13.3	9.8	7.1	8.9	6.3	135
140	31.4	31.5	28.7	21.3	17	12.9	9.5	6.8	8.6	6	140
145	29.3	29.4	28.1	20.8	16.5	12.5	9.1	6.5	8.3	5.8	145
150	27.3	27.4	27.6	20.3	16.1	12.1	8.8	6.3	8	5.6	150
155	25.4	25.5	26.2	19.8	15.7	11.7	8.6	6	7.8	5.4	155
160	23.6	23.7	24.6	19.3	15.3	11.3	8.3	5.8	7.5	5.2	160
165	22	22.1	22.9	18.9	15	10.9	8	5.6	7.3	5	165
170	20.3	20.5	21.3	18.4	14.6	10.6	7.8	5.3	7.1	4.8	170
175	18.8	18.9	19.8	18	14.2	10.3	7.5	5.1	6.9	4.6	175
180	17.4	17.5	18.4	17.6	13.9	10.1	7.3	4.9	6.7	4.4	180
185	16	16.1	17	17.1	13.6	9.8	7.1	4.8	6.5	4.2	185
190	14.7	14.8	15.6	16.1	13.3	9.6	6.9	4.6	6.3	4.1	190
195		13.6	14.4	14.9	13	9.4	6.7	4.4	6.1		195
200		12.4	13.2	13.7	12.8	9.1	6.6	4.2	5.9		200
205			12	12.5	12.6	8.9	6.4	4.1	5.8		205
210			10.9	11.4	12.3	8.7	6.2	3.9	5.6		210
215			9.9	10.3	11.2	8.5	6	3.8	5.5		215
220			9.2	9.5	10.2	8.3	5.9	3.6	5.3		220
225				8.8	9.4	8.1	5.7	3.5	5.2		225
230				8.2	8.7	7.9	5.5	3.3	5		230
235				7.5	8.1	7.8	5.4	3.2	4.9		235
240				6.9	7.5	7.4	5.3		4.8		240
245					6.9	6.9	5.2		4.6		245
250					6.4	6.4	5.1		4.5		250
255					5.8	5.9	4.9		4.3		255
260					5.3	5.3	4.8		4.2		260
265					4.8	4.8	4.7		4		265
270						4.4	4.5		3.8		270
275						3.9	4		3.5		275
280						3.5	3.6		3.1		280
285						3.1	3.2				285
290							2.7				290
295							2.4				295
I	92	92	92	92	92	92	92	92	100	100	I
II	92	92	92	92	92	92	92	92	100	100	II
III	46	92	92	92	92	92	92	92	100	100	III
IV	46	46	92	92	92	92	92	92	100	100	IV

* adapter / pièce d'adaptateur

TAB 122375

The LTM 1300/1 can be equipped to tackle any job.

Lifting capacities on the lattice fly jib with guyed telescopic boom.

LTM 1300/1

Forces de levage à la fléchette treillis fixe avec flèche télescopique haubanée.



151 ft - 185 ft

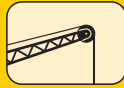

20° / 40°
46 ft - 138 ft



29' x 27'11"



360°



247500 lbs



85%

ft	151 ft + 8 ft*		168 ft + 8 ft*		185 ft + 8 ft*								ft		
	46 ft		46 ft		46 ft		69 ft		92 ft		115 ft			138 ft	
	20°	40°	20°	40°	20°	40°	20°	40°	20°	40°	20°	40°		20°	
60	46.5		45.1												60
65	45.2		44												65
70	44	27.5	42.9		35.5										70
75	42.7	26.9	42	26.8	34.5										75
80	41.4	26.4	41	26.3	33.6	26.1	24.2								80
85	40.2	25.9	40.1	25.9	32.8	25.6	23.5								85
90	39.2	25.4	39.1	25.5	32	25.2	22.8								90
95	38.2	25	38.2	25	31.2	24.8	22.2		17.1						95
100	37.3	24.6	37.4	24.6	30.5	24.5	21.6	15.1	16.6						100
105	36.4	24.3	36.6	24.3	29.8	24.1	21	14.8	16.2						105
110	35.5	23.9	35.8	24	29.1	23.8	20.4	14.6	15.8						110
115	34.7	23.7	35	23.7	28.5	23.6	19.9	14.3	15.5	9	10.8				115
120	34	23.4	34.3	23.5	27.9	23.3	19.4	14.1	15.1	8.8	10.5				120
125	33.4	23.1	33.6	23.2	27.3	23	19	13.9	14.8	8.7	10.2		7		125
130	32.7	22.8	33.1	23	26.8	22.8	18.5	13.7	14.4	8.5	9.9		6.8		130
135	32.2	22.7	32.6	22.7	26.3	22.6	18.1	13.5	14.1	8.4	9.7	5.3	6.6		135
140	31.6	22.6	32	22.6	25.8	22.5	17.7	13.3	13.7	8.3	9.4	5.2	6.4		140
145	30.9	22.5	31.2	22.5	25.4	22.3	17.4	13.1	13.4	8.2	9.1	5.1	6.3		145
150	28.9	22.5	29.1	22.5	25	22.2	17	13	13.1	8.1	8.8	5	6.1		150
155	26.9	22.4	27.1	22.4	24.5	22.1	16.7	12.9	12.8	7.9	8.6	4.9	5.9		155
160	25	22.3	25.3	22.4	24.2	22	16.3	12.8	12.5	7.8	8.4	4.9	5.8		160
165	23.2	22.2	23.5	22.3	23.8	21.9	16	12.7	12.2	7.7	8.2	4.8	5.6		165
170	21.5	21.8	21.8	22.3	22.7	21.9	15.8	12.6	11.9	7.6	8	4.7	5.4		170
175	19.9	20.1	20.2	20.8	21.2	21.4	15.6	12.5	11.7	7.6	7.8	4.6	5.3		175
180	18.3		18.6	19.2	19.6	20.3	15.3	12.4	11.4	7.5	7.7	4.6	5.2		180
185	16.8		17.2	17.6	18.2	18.8	15.1	12.4	11.2	7.5	7.5	4.5	5		185
190	15.3		15.8	16	16.8	17.3	14.9	12.4	11	7.4	7.3	4.4	4.9		190
195			14.4		15.4	15.9	14.7	12.4	10.8	7.4	7.2	4.4	4.7		195
200			13.1		14.2	14.5	14.5	12.4	10.7	7.3	7.1	4.4	4.6		200
205					12.9		14	12.4	10.5	7.3	6.9	4.3	4.5		205
210					11.7		12.9	12.4	10.4	7.3	6.8	4.3	4.4		210
215					10.5		11.8	12.1	10.2	7.3	6.7	4.3	4.3		215
220					9.5		10.6	11.2	10.1	7.3	6.6	4.2	4.2		220
225							9.7	10	9.9	7.3	6.5	4.2	4.1		225
230							8.9		9.7	7.3	6.4	4.2	4		230
235							8.2		9.3	7.3	6.3	4.2	3.9		235
240							7.5		8.6	7.3	6.2	4.2	3.8		240
245									7.9	7.3	6.1	4.2	3.8		245
250									7.3		6	4.2	3.7		250
255									6.6		5.9	4.2	3.6		255
260									6		5.8	4.2	3.5		260
265									5.4		5.7	4.2	3.5		265
270											5.4	4.2	3.4		270
275											4.9	4.2	3.3		275
280											4.3		3.2		280
285											3.7		3.1		285
290													3		290
295													2.9		295
300													2.8		300
I	92		92		92		92		92		92		92	I	
II	92		92		92		92		92		92		92	II	
III	46		92		92		92		92		92		92	III	
% IV	46		46		92		92		92		92		92	IV	

* adapter / pièce d'adaptateur

TAB 122376 / 122377

Lifting heights. Hauteurs de levage.

Lattice fly jib on guyed telescopic boom.
Fléchette treillis fixe à la flèche télescopique haubanée.

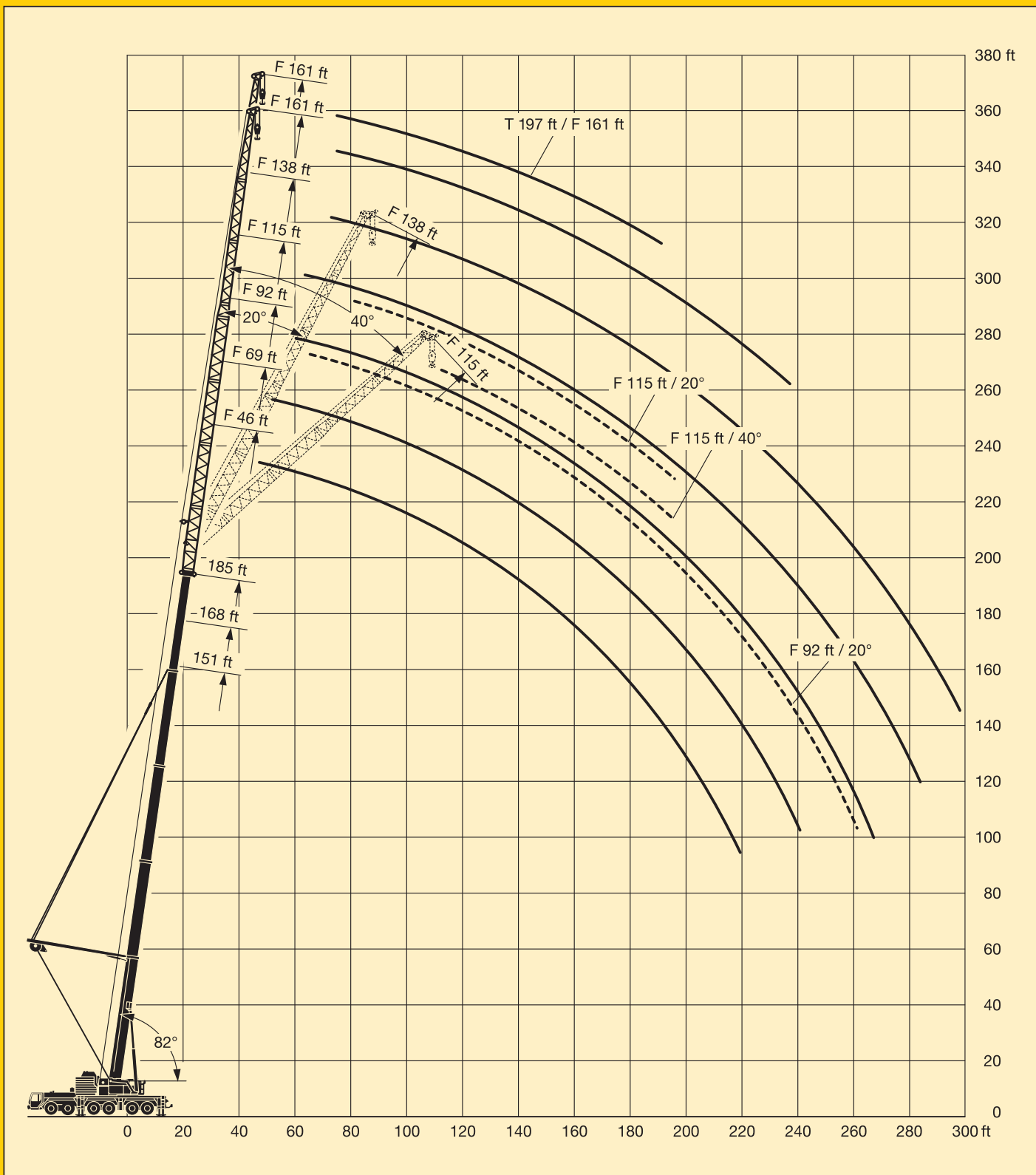

Lifting capacities on the luffing lattice jib. Forces de levage à la fléchette treillis relevable.

LTM 1300/1



82°
49 ft - 185 ft



57 ft - 230 ft



29' x 27'11"



360°



192500 lbs

85%

ft	49 ft + 13 ft*									83 ft + 13 ft*						ft
	57 ft	69 ft	92 ft	115 ft	138 ft	161 ft	184 ft	207 ft	230 ft	57 ft	69 ft	92 ft	115 ft	138 ft	161 ft	
30	170															30
32	165															32
34	160	150								133						34
36	156	146								133						36
38	152	142								133						38
40	148	139	118							133	112					40
45	140	131	114							133	111					45
50	135	125	110	90.5						131	111	88.5				50
55	124	119	106	88.5	71.5					125	111	87.5	68			55
60		114	102	86.5	70.5					115	110	86.5	68	53.3		60
65		108	98.5	84.5	69.5					105	105	85	68	53.3		65
70		91	94	82	68	54.8					97.5	83.5	67	53.3	41	70
75			88.5	80	67	54.3	42					82	66	53.2	41	75
80			82	77.5	65.5	53.4	42	31.5				80.5	65	52.8	41	80
85			74.5	74	64.5	52.4	42	31.5				78	64	52	41	85
90			63.5	70	63	51.2	41.7	31.5	23.3			73.5	63	51.2	41	90
95				66	61.5	50	41	31.5	22.8			66.5	62	50.3	40.9	95
100				62	59.4	48.9	40.2	31.4	22.3				61	49.4	40.5	100
105				57.5	56.3	47.7	39.2	31.1	21.8				60	48.4	39.7	105
110				49.9	53.3	46.7	38.3	30.6	21.4				57.5	47.5	38.9	110
115					50.6	45.7	37.5	30.2	20.9				52.8	46.7	38.1	115
120					48.3	44.6	36.6	29.7	20.5					45.9	37.4	120
125					45.9	43.5	35.8	29.1	20.1					45.1	36.7	125
130					41.6	41.4	35.1	28.5	19.7					44.3	36	130
135					36.9	39.5	34.3	27.8	19.3					42.5	35.4	135
140						37.9	33.6	27.2	19						34.8	140
145						36.3	32.9	26.6	18.6						34.3	145
150						34.3	32.3	26	18.4						33.8	150
155						30.6	31.2	25.6	18.1						33.4	155
160							30.1	25.3	17.9						31.4	160
165							29.1	25.2	17.7							165
170							28	25	17.6							170
175							25.6	24.8	17.5							175
180								24.4	17.4							180
185								23.6	17.1							185
190								22.9	16.6							190
195								21.4	16							195
200								19.2	15.5							200
205									15							205
210									14.5							210
215									14.1							215
220									13.6							220
I					0								46			I
II					0								46			II
III					0								0			III
% IV					0								0			IV %

* adapter / pièce d'adaptateur

TAB 122378.1/2

Fortsetzung

Lifting capacities on the luffing lattice jib. Forces de levage à la fléchette treillis relevable.

LTM 1300/1



82°
49 ft – 185 ft



57 ft – 230 ft



29' x 27'11"



360°



192500 lbs



85%

ft	83 ft + 13 ft*			117 ft + 13 ft*									151 ft + 13 ft*			ft	
	184 ft	207 ft	230 ft	57 ft	69 ft	92 ft	115 ft	138 ft	161 ft	184 ft	207 ft	230 ft	57 ft	69 ft	92 ft		
40				91.5												40	
45				91.5												45	
50				91.5	78.5											50	
55				90.5	78.5	61.5							55.2	47.2		55	
60				88.5	78.5	61.5	48.2						55.2	47.2	35.7	60	
65				85.5	78.5	61.5	48.2						55.2	47.2	35.7	65	
70					77	61.5	48.2	37.5					55.2	47.2	35.7	70	
75	31				75	61.5	48.2	37.5	28.3					47.2	35.7	75	
80	31					60.5	48.2	37.5	28.3					47.2	35.7	80	
85	31					60	48.2	37.5	28.3					47.2	35.7	85	
90	31	24.1				59.4	47.7	37.5	28.3	22					35.7	90	
95	31	24.1	17.6			59	47.2	37.5	28.3	22	16.1				35.7	95	
100	31	24.1	17.6				46.7	37.5	28.3	22	16.1	11.3			35.7	100	
105	31	24.1	17.6				46.3	37.5	28.3	22	16.1	11.3				105	
110	31	24.1	17.6				45.8	37.2	28.3	22	16.1	11.3				110	
115	30.8	24.1	17.6				45.4	36.7	28.3	22	16.1	11.3				115	
120	30.4	24.1	17.6				45	36.3	28.3	22	16.1	11.3				120	
125	29.8	24.1	17.4					35.8	28.3	22	16.1	11.3				125	
130	29.2	23.7	17.1					35.3	28.2	22	16.1	11.3				130	
135	28.6	23.3	16.8					34.9	27.9	22	16.1	11.3				135	
140	28.1	22.8	16.6					34.6	27.5	21.9	16.1	11.3				140	
145	27.5	22.4	16.3						27.1	21.8	16.1	11.3				145	
150	27	22	16.1						26.7	21.4	16.1	11.3				150	
155	26.6	21.7	15.8						26.4	21	16.1	11.3				155	
160	26.3	21.4	15.7						26.2	20.8	16.1	11.3				160	
165	26.2	21.1	15.6						26.2	20.6	16.1	11.3				165	
170	26	20.9	15.5						26.2	20.4	16.1	11.3				170	
175	25.8	20.7	15.4							20.4	16	11.3				175	
180	25.6	20.6	15.3							20.4	15.9	11.3				180	
185		20.5	15.3							20.4	15.8	11.3				185	
190		20.4	15.2							20.4	15.8	11.3				190	
195		20.4	15.2								15.8	11.3				195	
200		20.4	15								15.8	11.3				200	
205		19.6	14.7								15.8	11.3				205	
210			14.2									11.3				210	
215			13.8									11.3				215	
220			13.5									11.3				220	
225			13.2									11.3				225	
230												11.3				230	
235												11.3				235	
ft	I	46			92									92			I
	II	46			46									46			II
	III	0			46									46			III
	IV	0			0									46			IV

* adapter / pièce d'adaptateur

TAB 122378.3/4

Fortsetzung

Lifting capacities on the luffing lattice jib. Forces de levage à la flèche treillis relevable.

LTM 1300/1



82°
49 ft - 185 ft



57 ft - 230 ft



29' x 27'11"



360°



192500 lbs



85%

ft	151 ft + 13 ft*						185 ft + 13 ft*						m	
	115 ft	138 ft	161 ft	184 ft	207 ft	230 ft	57 ft	69 ft	92 ft	115 ft	138 ft	161 ft		184 ft
60							33.2	28.5						60
65							33.2	28.5						65
70	26.7						33.2	28.5	20.7					70
75	26.7	20					33	28.5	20.7	15				75
80	26.7	20	14.6					28.5	20.7	15				80
85	26.7	20	14.6					28.5	20.7	15				85
90	26.7	20	14.6					28.3	20.7	15	10.7			90
95	26.7	20	14.6	10.1					20.7	15	10.7	7.2		95
100	26.7	20	14.6	10.1	6.8				20.7	15	10.7	7.2	4.3	100
105	26.7	20	14.6	10.1	6.8	4			20.7	15	10.7	7.2	4.3	105
110	26.7	20	14.6	10.1	6.8	4			20.7	15	10.7	7.2	4.3	110
115	26.7	20	14.6	10.1	6.8	4				15	10.7	7.2	4.3	115
120	26.7	20	14.6	10.1	6.8	4				15	10.7	7.2	4.3	120
125	26.7	20	14.6	10.1	6.8	4				15	10.7	7.2	4.3	125
130	26.7	20	14.6	10.1	6.8	4				15	10.7	7.2	4.3	130
135		20	14.6	10.1	6.8	4					10.7	7.2	4.3	135
140		20	14.6	10.1	6.8	4					10.7	7.2	4.3	140
145		20	14.6	10.1	6.8	4					10.7	7.2	4.3	145
150		20	14.6	10.1	6.8	4					10.7	7.2	4.3	150
155			14.6	10.1	6.8	4					10.7	7.2	4.3	155
160			14.6	10.1	6.8	4						7.2	4.3	160
165			14.6	10.1	6.8	4						7.2	4.3	165
170			14.6	10.1	6.8	4						7.2	4.3	170
175				10.1	6.8	4						7.2	4.3	175
180				10.1	6.8	4							4.3	180
185				10.1	6.8	4							4.3	185
190				10.1	6.8	4							4.3	190
195				10.1	6.8	4							4.3	195
200					6.8	4								200
205					6.8	4								205
210					6.8	4								210
215					6.8	4								215
220						4								220
225						4								225
230						4								230
235						4								235
I					92						92			I
II					92						92			II
III					46						92			III
% IV					46						92			IV

* adapter / pièce d'adaptateur

TAB 122378.5

Lifting heights. Hauteurs de levage.

LTM 1300/1

Luffing lattice jib.
Fléchette treillis relevable.

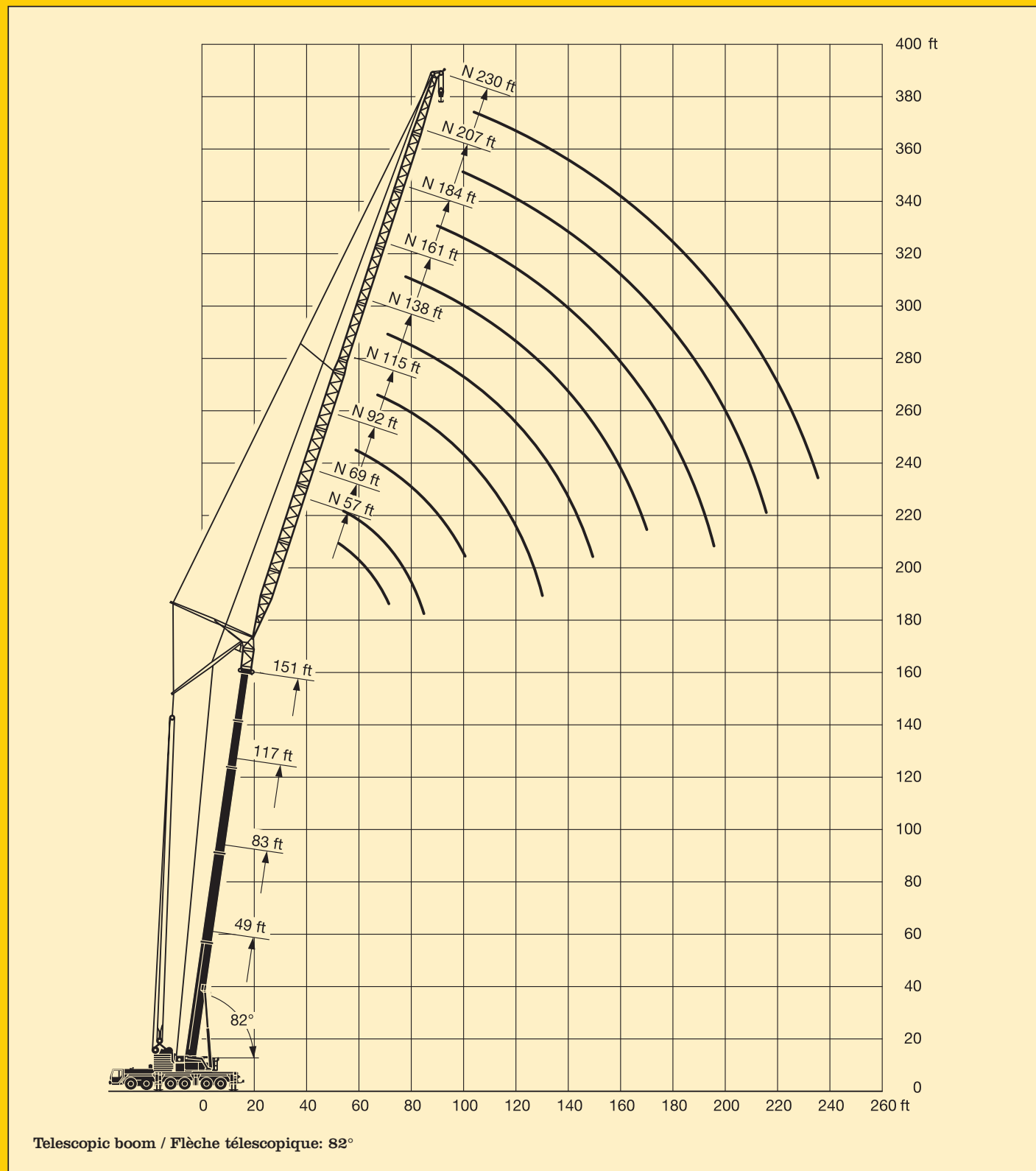

Lifting capacities on the luffing lattice jib. Forces de levage à la fléchette treillis relevable.

LTM 1300/1



74°
49 ft – 185 ft



57 ft – 230 ft



29' x 27'11"



360°



192500 lbs



85%

ft	49 ft + 13 ft*									83 ft + 13 ft*						ft
	57 ft	69 ft	92 ft	115 ft	138 ft	161 ft	184 ft	207 ft	230 ft	57 ft	69 ft	92 ft	115 ft	138 ft	161 ft	
50	128															50
55	121	116														55
60	114	109	100							107	106					60
65	105	104	95.5							98.5	98					65
70		97	92							91.5	91					70
75		90.5	88	78.5						85	84.5	82				75
80			83.5	76	64.5						78.5	77.5				80
85			78.5	73.5	63						73.5	72.5				85
90			74	71	62						69	68	65.5			90
95			69.5	68	60.5	50.4						63.5	62.5	51.8		95
100			63.5	64.5	59.3	49.6	40.5					60	59	51.8		100
105				61	57.9	48.7	40.5					56.7	55.6	51.8	39.8	105
110				57.9	56.5	47.9	39.9					53.7	52.7	50.8	39.8	110
115				54.9	54.1	47.2	39.3	29.9					49.9	48.7	39.8	115
120				51.3	51.4	46.5	38.7	29.7					47.5	46.2	39.8	120
125					48.9	46	38.2	29.3	20.2				45.1	43.9	39.8	125
130					46.6	45.2	37.7	29	19.8				43	41.8	39.8	130
135					44.5	43.5	37.2	28.6	19.4					39.9	38.8	135
140					42.1	41.6	36.8	28.3	19.1					38.1	37.3	140
145					38.8	39.7	36.4	27.9	18.8					36.4	35.6	145
150					33.1	38.1	35.9	27.6	18.5					34.9	34.1	150
155						36.4	35.1	27.4	18.3					33.5	32.6	155
160						34.9	33.9	27.3	18.1						31.3	160
165						33.1	32.5	27.1	17.9						30	165
170						29	31.2	26.9	17.8						28.8	170
175							30	26.8	17.6						27.7	175
180							28.9	26.6	17.4							180
185							27.4	26.3	17.2							185
190							24.8	25.7	17							190
195							21.5	24.7	16.9							195
200								23.8	16.5							200
205								22.7	15.9							205
210								21.2	15.3							210
215								18.6	14.8							215
220									14.3							220
225									13.8							225
230									13.5							230
235									13.3							235
I					0								46			I
II					0								46			II
III					0								0			III
IV					0								0			IV

* adapter / pièce d'adaptateur

TAB 122379.1/2

Fortsetzung

Lifting capacities on the luffing lattice jib. Forces de levage à la flèche treillis relevable.

LTM 1300/1



74°
49 ft – 185 ft



57 ft – 230 ft



29' x 27'11"



360°



192500 lbs

85%

ft	83 ft + 13 ft*			117 ft + 13 ft*									151 ft + 13 ft*			ft
	184 ft	207 ft	230 ft	57 ft	69 ft	92 ft	115 ft	138 ft	161 ft	184 ft	207 ft	230 ft	57 ft	69 ft	92 ft	
75				72	69.5											75
80				68.5	66.5											80
85				65.5	63.5											85
90					61	56.3							44.7			90
95					58.4	54.4	46.6						42.9	41.3		95
100						52.5	46.5							39.7	35.3	100
105						50.6	46.1	35.9							34.7	105
110						48.4	44.8	35.9							33.7	110
115	29.7					46.1	43.6	35.9							32.6	115
120	29.7						42.2	35.9	27.1						31.5	120
125	29.7	22.8					40.6	35.9	27.1	20.7					30.5	125
130	29.7	22.8					38.7	35.9	27.1	20.7					29.8	130
135	29.7	22.8	16.5				36.9	35.2	27.1	20.7						135
140	29.7	22.8	16.5				35.2	33.9	27.1	20.7	15					140
145	29.7	22.8	16.4					32.4	27.1	20.7	15	10.4				145
150	29.7	22.8	16.1					30.9	27.1	20.7	15	10.4				150
155	29.7	22.8	15.9					29.6	27.1	20.7	15	10.4				155
160	29.3	22.8	15.8					28.4	26.8	20.7	15	10.4				160
165	28.5	22.8	15.7						26	20.7	15	10.4				165
170	27.3	22.8	15.6						24.9	20.7	15	10.4				170
175	26.2	22.8	15.5						23.9	20.7	15	10.4				175
180	25.2	22.8	15.4						22.9	20.7	15	10.4				180
185	24.1	22.7	15.3						22	20.5	15	10.4				185
190	23.2	22.3	15.2						21.2	19.8	15	10.4				190
195	22.3	21.5	15.1							19	15	10.4				195
200	21.5	20.6	15							18.2	15	10.4				200
205		19.8	14.9							17.5	15	10.4				205
210		19	14.8								15	10.4				210
215		18.3	14.6								14.6	10.4				215
220		17.6	14.4								14.1	10.4				220
225			14.1								13.4	10.4				225
230			13.7								12.9	10.4				230
235			13.5								12.3	10.4				235
240			13.3									10.1				240
245			13									9.7				245
250												9.4				250
255												9.1				255
I		46						92						92		I
II		46						46						46		II
III		0						46						46		III
IV		0						0						46		IV

* adapter / pièce d'adaptateur

TAB 122379.3/4

Fortsetzung

La LTM 1300/1 possède l'équipement qui convient à chaque problème.

Lifting capacities on the luffing lattice jib. Forces de levage à la fléchette treillis relevable.

LTM 1300/1



74°
49 ft – 185 ft



57 ft – 230 ft



29' x 27'11"



360°



192500 lbs

85%

ft	151 ft + 13 ft*						185 ft + 13 ft*						ft	
	115 ft	138 ft	161 ft	184 ft	207 ft	230 ft	57 ft	69 ft	92 ft	115 ft	138 ft	161 ft		184 ft
100							26.2							100
105								23.2						105
110								22.3						110
115	26.7							21.5	18.6					115
120	26.7	19.9							17.9					120
125	26.7	19.9							17.4	14.3				125
130	26.4	19.9							16.8	13.9				130
135	25.8	19.9	14.4						16.2	13.4				135
140	25.1	19.9	14.4	9.8						13	10.4			140
145	24.4	19.9	14.4	9.8						12.5	10	7.2		145
150	23.7	19.9	14.4	9.8						12.1	9.7	7.2		150
155		19.9	14.4	9.8	6.5					11.7	9.3	7.2		155
160		19.8	14.4	9.8	6.5					11.3	9	7.1	4.3	160
165		19.6	14.4	9.8	6.5	3.8					8.7	7	4.3	165
170		19.1	14.4	9.8	6.5	3.8					8.5	6.8	4.3	170
175		18.8	14.4	9.8	6.5	3.8					8.2	6.6	4.3	175
180			14.4	9.8	6.5	3.8					8	6.4	4.3	180
185			14.4	9.8	6.5	3.8						6.2	4.3	185
190			14.4	9.8	6.5	3.8						6	4.3	190
195			14.4	9.8	6.5	3.8						5.8	4.1	195
200				9.8	6.5	3.8						5.7	4	200
205				9.8	6.5	3.8						5.5	3.8	205
210				9.8	6.5	3.8							3.7	210
215				9.8	6.5	3.8							3.5	215
220				9.8	6.5	3.8							3.4	220
225					6.5	3.8							3.3	225
230					6.5	3.8								230
235					6.5	3.8								235
240					6.5	3.8								240
245						3.8								245
250						3.8								250
255						3.8								255
260						3.8								260
265						3.8								265
I				92							92			I
II				92							92			II
III				46							92			III
IV				46							92			IV

* adapter / pièce d'adaptateur

TAB 122379.5

Lifting heights. Hauteurs de levage.

LTM 1300/1

Luffing lattice jib.
Fléchette treillis relevable.

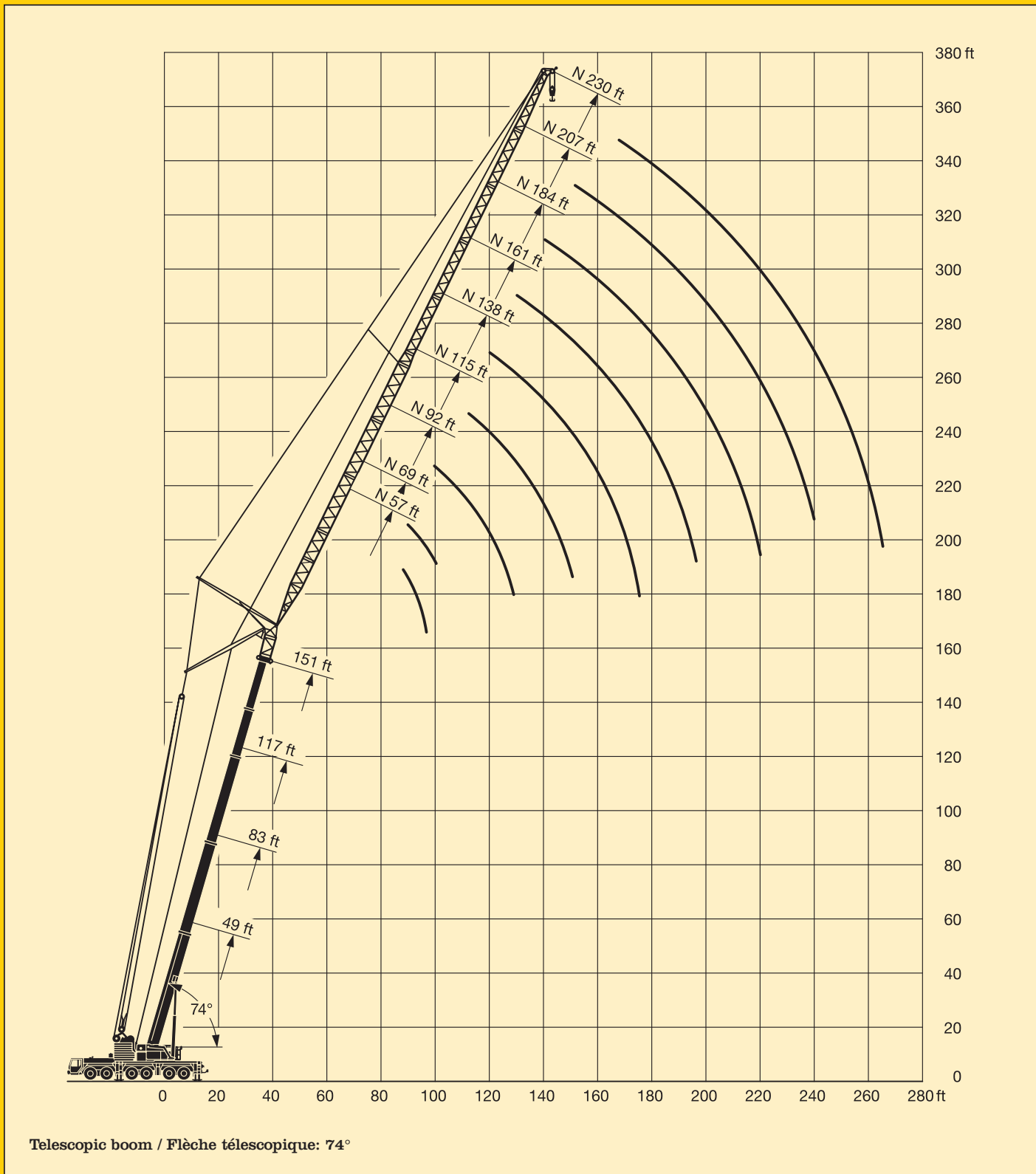

Lifting capacities on the luffing lattice jib. Forces de levage à la fléchette treillis relevable.

LTM 1300/1



66°
49 ft – 185 ft



57 ft – 230 ft

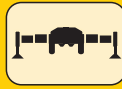

29' x 27'11"



360°



192500 lbs



85%

ft	49 ft + 13 ft*									83 ft + 13 ft*						ft
	57 ft	69 ft	92 ft	115 ft	138 ft	161 ft	184 ft	207 ft	230 ft	57 ft	69 ft	92 ft	115 ft	138 ft	161 ft	
60	110															60
65	101															65
70	94	93.5														70
75	87.5	87														75
80		81.5	80.5							73.5						80
85		76.5	75.5							68.5						85
90			71							64.5	63.5					90
95			66.5	65.5							59.9					95
100			62.5	61.5								55.1				100
105			59.2	58.2	57.1							51.9				105
110			56.2	55.2	54.2							49.2				110
115				52.3	51.4							46.6	45.5			115
120				49.7	48.8	45.6						44.3	43.2			120
125				47.3	46.4	44.8							41.1	39.7		125
130				45.2	44.3	43.1							39.1	37.8		130
135					42.3	41.2	36.3						37.3	36		135
140					40.4	39.3	35.8						35.6	34.4	33.5	140
145					38.6	37.6	35.3	27.5						32.8	31.9	145
150					37	35.9	34.6	27.2						31.3	30.5	150
155					35.5	34.4	33.3	27.1						30	29.1	155
160						33	31.9	27	17.9					28.8	27.9	160
165						31.7	30.6	27	17.7					27.6	26.7	165
170						30.5	29.3	26.9	17.6					26.5	25.6	170
175						29.3	28.1	26.7	17.6						24.5	175
180							27	25.9	17.5						23.6	180
185							26	24.9	17.4						22.6	185
190							25	23.9	17.4						21.8	190
195							24.1	23	17.3							195
200							23.2	22.1	17.1							200
205								21.3	16.8							205
210								20.4	16.3							210
215								19.7	15.7							215
220								19	15.2							220
225									14.6							225
230									14.1							230
235									13.7							235
240									13.4							240
245									13.1							245
I					0							46				I
II					0							46				II
III					0							0				III
IV					0							0				IV

* adapter / pièce d'adaptateur

TAB 122380.1/2

Fortsetzung

Lifting capacities on the luffing lattice jib. Forces de levage à la flèche treillis relevable.

LTM 1300/1



66°
49 ft – 185 ft



57 ft – 230 ft



29' x 27'11"



360°



192500 lbs



85%

ft	83 ft + 13 ft*			117 ft + 13 ft*							151 ft + 13 ft*							185 ft + 13 ft*				ft						
	184 ft	207 ft	230 ft	57 ft	69 ft	92 ft	115 ft	138 ft	161 ft	184 ft	207 ft	230 ft	57 ft	69 ft	92 ft	115 ft	138 ft	161 ft	184 ft	207 ft	230 ft		69 ft	92 ft	115 ft	138 ft		
95				53.1																							95	
100				50	49																							100
105					46.3																							105
110					43.8																							110
115					41.5	40.1							31.8															115
120						38								29.6														120
125							36	34.9						28.3														125
130							34.3	33.1						27.2														130
135							32.7	31.5							24.1													135
140							30	28.6							23.2													140
145															22.4	20.5							15					145
150															21.6	19.7												150
155	27.5						26.2	24.8	23.4						18.9									11				155
160	26.3						25.1	23.6	22.3						18.2	16.6							10.5					160
165	25.1	22						22.6	21.2	19.7					17.5	15.9										8.2		165
170	24	22						21.6	20.2	18.8					16.9	15.2										7.8		170
175	23	21.8						20.7	19.3	17.9					16.6	14.6	12.9									7.5		175
180	22	21.1	15.2					19.8	18.4	17	14.6					14.1	12.3									7.2	5.9	180
185	21	20.1	15.2						17.6	16.2	14.5					13.6	11.8	9.6								7	5.6	185
190	20.2	19.3	15.1						16.8	15.4	13.8					13.1	11.2	9.3								6.7	5.4	190
195	19.3	18.4	15.1						16.1	14.6	13	10.4				12.8	10.8	8.9									5.2	195
200	18.5	17.6	15.1						15.4	13.9	12.2	10.2					10.3	8.5	6.5								4.9	200
205	17.8	16.8	15						14.8	13.2	11.5	9.8					9.9	8.1	6.5								4.7	205
210	17.1	16.1	14.7							12.5	10.8	9.4					9.5	7.8	6.5									210
215	16.5	15.4	14							11.9	10.2	8.9					9.3	7.5	6.3									215
220		14.8	13.3							11.3	9.7	8.5					9.1	7.3	6	3.8								220
225		14.1	12.7							10.7	9.4	8.2					7	5.8	3.8									225
230		13.5	12.1								9	7.8						6.8	5.5	3.8								230
235		13	11.5								8.7	7.5						6.6	5.3	3.8								235
240			10.9								8.4	7.2						6.6	5.1	3.8								240
245			10.4								8.1	6.9							4.9	3.6								245
250			9.9								7.8	6.6							4.7	3.5								250
255			9.6								7.5	6.3							4.6	3.3								255
260			9.3									6							4.5	3.1								260
265												5.8							4.3	2.9								265
270												5.6								2.8								270
275												5.4								2.7								275
280																				2.5								280
I	46						92											92									I	
II	46						46											92									II	
III	0						46											46									III	
IV	0						0											46									IV	

* adapter / pièce d'adaptateur

TAB 122380.3/4/5

Lifting heights. Hauteurs de levage.

LTM 1300/1

Luffing lattice jib.
Fléchette treillis relevable.

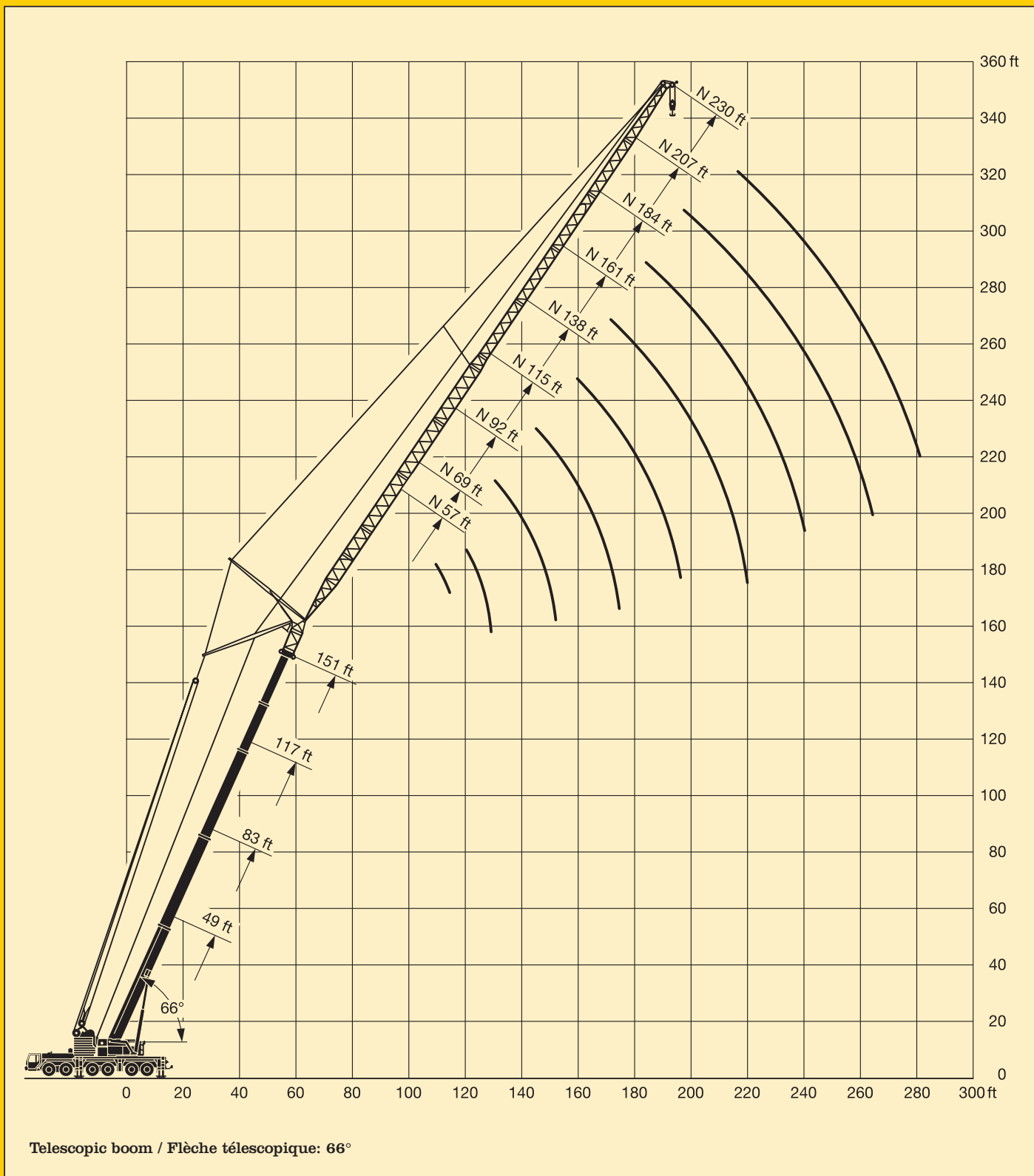

Lifting capacities on the luffing lattice fly jib with guyed telescopic boom.

LTM 1300/1

Forces de levage à la fléchette treillis relevable avec flèche télescopique haubanée.



66°
117 ft – 185 ft



69 ft – 230 ft



29' x 27'11"



360°



247500 lbs



85%

ft	117 ft + 13 ft*								151 ft + 13 ft*			ft
	69 ft	92 ft	115 ft	138 ft	161 ft	184 ft	207 ft	230 ft	69 ft	92 ft	115 ft	
100	57.1											100
105	54											105
110	51.3											110
115	48.8	47.1							39.2			115
120		44.8							39.2			120
125		42.6	41.5						39.1	30.8		125
130		40.7	39.5						37.7	30.7		130
135		38.9	37.7							30.6		135
140			36.1	34						30.6	24.1	140
145			34.5	33.1						30.5	24	145
150			33.1	31.7						29.9	23.9	150
155			31.7	30.3	25.8						23.9	155
160			30.5	29.1	25.8						23.9	160
165				27.9	25.8	19.8					23.9	165
170				26.8	25.4	19.8					23.9	170
175				25.8	24.5	19.8					23.3	175
180				24.8	23.5	19.8	14.6					180
185					22.6	19.8	14.6					185
190					21.7	19.8	14.6					190
195					20.9	19.3	14.6	10.2				195
200					20.1	18.7	14.6	10.2				200
205					19.3	17.9	14.6	10.2				205
210						17.2	14.6	10.2				210
215						16.5	14.6	10.2				215
220						15.8	14.3	10.2				220
225						15.2	13.7	10.2				225
230							13.1	10.2				230
235							12.5	10.2				235
240							12	10				240
245							11.4	9.8				245
250							10.9	9.4				250
255							10.5	9.1				255
260								8.8				260
265								8.5				265
270								8.2				270
275								8				275
I				92						92		I
II				46						46		II
III				46						46		III
IV				0						46		IV

* adapter / pièce d'adaptateur

TAB 122383.1

Fortsetzung

Lifting capacities on the luffing lattice fly jib with guyed telescopic boom.

LTM 1300/1

Forces de levage à la fléchette treillis relevable avec flèche télescopique haubanée.



66°
117 ft – 185 ft



69 ft – 230 ft

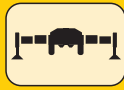

29' x 27'11"



360°



247500 lbs



85%

ft	151 ft + 13 ft*					185 ft + 13 ft*					ft	
	138 ft	161 ft	184 ft	207 ft	230 ft	69 ft	92 ft	115 ft	138 ft	161 ft		184 ft
135						21.2						135
140						21.1						140
145							16.3					145
150							16.2					150
155	18.5						16.1					155
160	18.5						16	11.9				160
165	18.5							11.9				165
170	18.5							11.9				170
175	18.5	13.7						11.9	8.5			175
180	18.5	13.7						11.9	8.5			180
185	18.5	13.7	9.4					11.9	8.5			185
190	18.5	13.7	9.4					11.9	8.5			190
195	18.3	13.7	9.4						8.5	6.1		195
200		13.7	9.4	6.2					8.5	6.1		200
205		13.7	9.4	6.2					8.5	6.1	3.7	205
210		13.7	9.4	6.2	3.5					6.1	3.7	210
215		13.7	9.4	6.2	3.5					6.1	3.7	215
220		13.6	9.4	6.2	3.5					6.1	3.7	220
225			9.4	6.2	3.5					6.1	3.7	225
230			9.4	6.2	3.5					6.1	3.7	230
235			9.4	6.2	3.5					6.1	3.7	235
240			9.4	6.2	3.5						3.7	240
245				6.2	3.5						3.7	245
250				6.2	3.5						3.7	250
255				6.2	3.5						3.7	255
260				6.2	3.5							260
265				6.2	3.5							265
270					3.5							270
275					3.5							275
280					3.5							280
285					3.5							285
I				92						92		I
II				92						92		II
III				46						92		III
% IV				46						92		IV %

* adapter / pièce d'adaptateur

TAB 122383.2

Lifting heights. Hauteurs de levage.

LTM 1300/1

Luffing lattice jib with guyed telescopic boom.
Fléchette treillis relevable avec flèche télescopique haubanée.

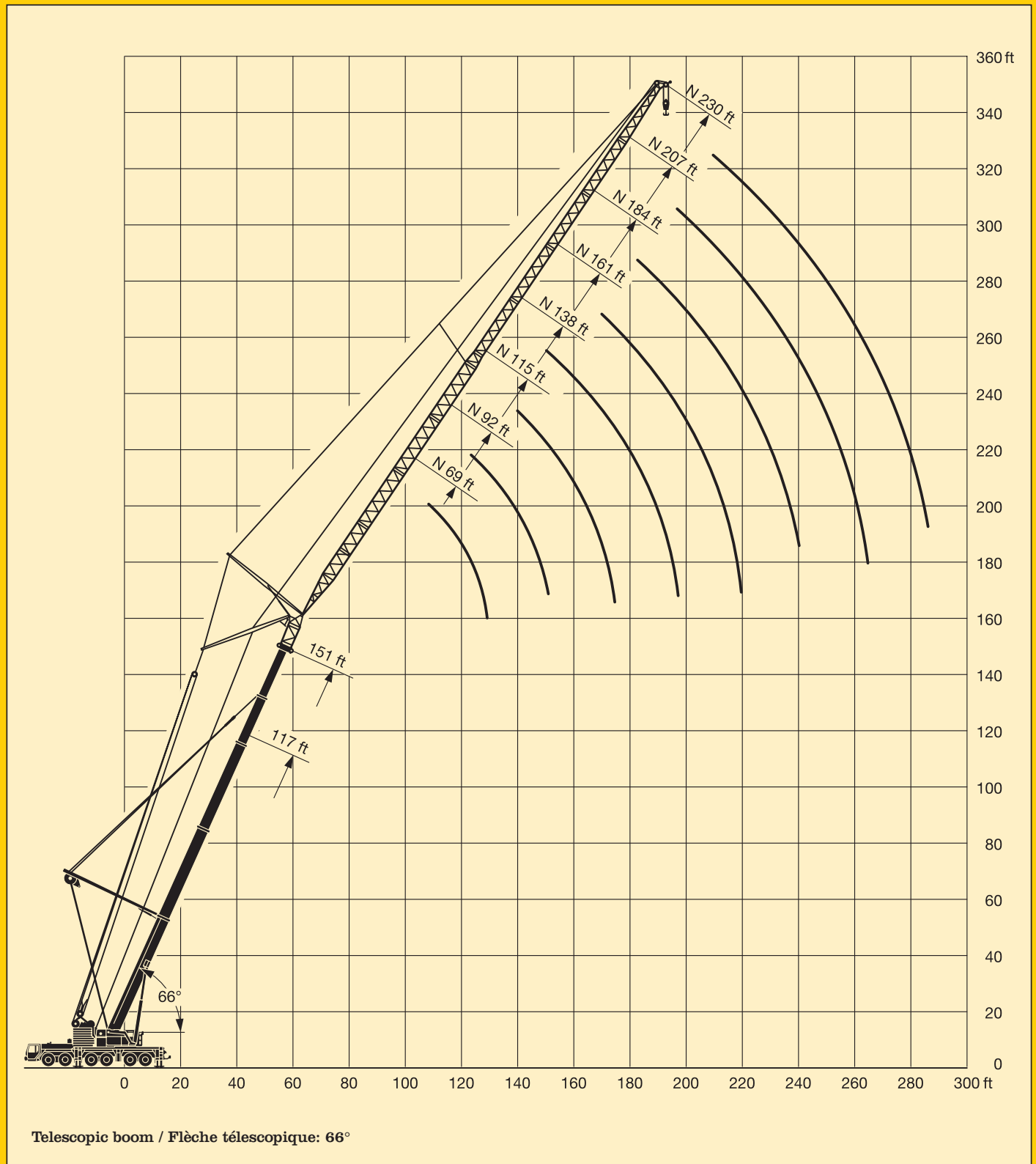

Dimensions. Encombrement.

LTM 1300/1

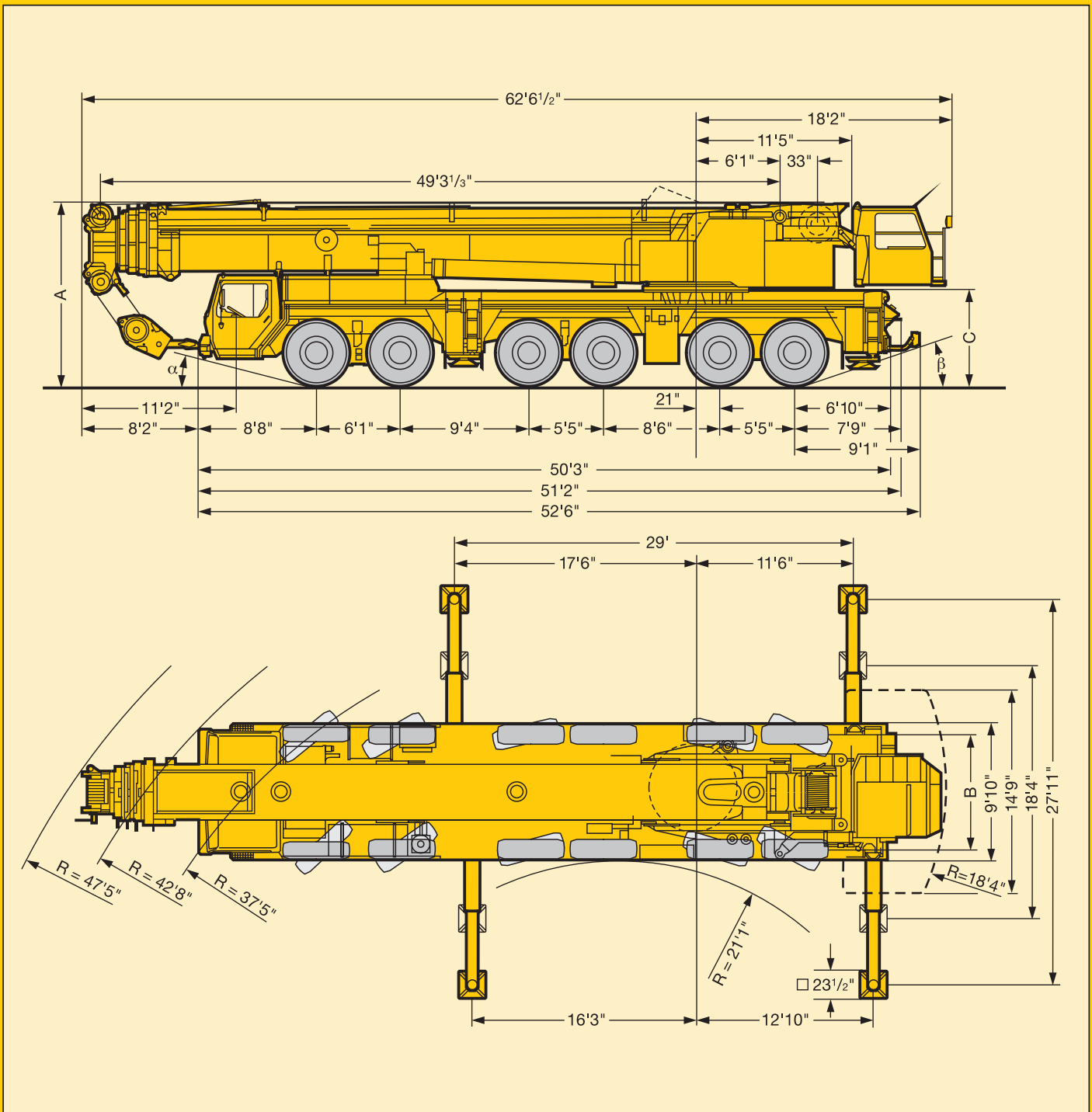

 16.00 R 25	Dimensions / Encombrement					
	A	A*	B	C	α	β
	13' 1 1/2"	12' 7 1/2"	8' 4 1/2"	6' 9"	17°	19°

* lowered / abaissé







Axle Essieu	1	2	3	4	5	6	Total weight Poids total
lbs	26500	26500	26500	26500	26500	26500	159000









Load (kips) Forces de levage (kips)	No. of sheaves Poulies	No. of lines Brins	Weight lbs Poids lbs
473	12	24	5280
387	9	18	3960
314	7	14	3740
238	5	10	3190
156	3	6	2200
70	1	3	1850
23	-	1	1100

Working speeds. Vitesses.



	1	2	3	4	5	R	 %
							
	9.3	15	23	34	47	8.7	-
	5	8.7	13.7	20	27.5	4.7	39 %
	16.00 R 25						



Drive Mécanismes	infinitely variable en continu	Rope diameter / Rope length Diamètre du câble / Longueur du câble	Max. single line pull Effort au brin maxi.
	0 - 460 ft/min single line ft/min au brin simple	$1\frac{1}{2}$ " / 1476'	23600 lbs
	0 - 460 ft/min single line ft/min au brin simple	$1\frac{1}{2}$ " / 1476'	23600 lbs
	0 - 460 ft/min single line ft/min au brin simple	$1\frac{1}{2}$ " / 2100'	23600 lbs
	0 - 1.5 rpm		
	approx. 70 seconds to reach 82° boom angle env. 70 s jusqu'à 82°		
	approx. 500 seconds for boom extension from 49 ft - 197 ft env. 500 s pour passer de 49 ft - 197 ft		

Crane carrier.

LTM 1300/1

Frame:	Liebherr designed and manufactured, box-type, torsion resistant design of high-tensile fine grained structural steel.
Outriggers:	Four hydraulically extendable sliding beams with hydraulic jacks and supporting pads. The front outrigger casing is mounted between axles 2 and 3 and the rear casing is located at the rear of the carrier. Supporting basis: 29' longitudinally x 27'11" transversally.
Engine:	8-cylinder Diesel engine, make Liebherr, type D 9408 TI-E, watercooled, output acc. to DIN 440 kW (598 HP) at 1900 rpm acc. to ECE-R 24.03 and ECE-R 49.02 (EURO III), max. torque 1915 lbs/ft at 1400 rpm. Fuel tank: 158 gallons.
Transmission:	Automatic transmission, make Allison, type CLBT 755, with torque converter and hydrodynamic brake, 5 forward speeds, 1 reverse. Transfer case with transfer differential and off-road ratio.
Axles:	Heavy-duty vehicle axles. All axles suspended. Axles 1 to 3 and 5 and 6 steered. Axles 1, 5 and 6 are planetary axles, intermediate differential at axle 5, all driven axles with transverse differential.
Cardan shaft:	All cardan shafts with 70° diagonal toothing.
Suspension:	All axles with hydropneumatic suspension and automatic levelling system. Load equalization between the axle pairs 1 + 2, 3 + 4 and 5 + 6. The suspension can be locked hydraulically.
Tyre equipment:	12 tyres, all axles equipped with single tyres. Size of tyres: 16.00 R 25.
Steering:	ZF semi-integral power steering, dual circuit system with hydraulic servo-system and additional backing pump driven by an axle.
Brakes:	Service brake: All-wheel servo-air brake, dual circuit system. Additional brakes: Retarder, TELMA-type eddy current brake (optional). Hand brake: Spring-loaded, acting on all wheels of axles 2 to 6.
Driving cab:	Spacious sheet steel cab mounted on rubber shock absorbers, safety glass windows, operating and control elements.
Electrical system:	Modern data bus technique, 24 Volt DC, 2 batteries of 170 Ah each, lighting according to traffic regulations.

Crane superstructure.

Frame:	Liebherr-made torsion resistant, welded construction of high-tensile structural steel, linked to carrier by a three-row roller slewing rim for 360° continuous rotation.
Crane engine:	4-cylinder Diesel engine, make Liebherr, type D 924 TI-E, watercooled, output acc. to DIN 180 kW (245 HP) at 1800 rpm, max. torque 770 lbs/ft at 1100 rpm. Fuel tank capacity: 79 gallons
Crane drive:	Diesel-hydraulic, with 3 axial piston variable displacement pumps, with servo-control and capacity control.
Crane control:	Two self-centering control levers (joy-sticks). Pedal switches for telescoping. Infinitely variable crane motions through displacement control of the hydraulic pumps. Additional working speed control by variation of the Diesel engine speed.
Hoist gear:	Axial piston variable displacement motor, Liebherr hoist drum with integrated planetary gear and spring-loaded static brake.
Luffing gear:	2 differential hydraulic rams with nonreturn valve.
Slewing gear:	Hydraulic motor, planetary gear, slewing pinion and spring-loaded static brake.
Crane cab:	Aluminium design with safety glass, operating and control elements. Cab tiltable backwards. The cab will be pivoted to the rear for road transport.
Safety devices:	LICCON safe load indicator, test system, hoist limit switches, safety valves against rupture of pipes and hoses.
Counterweight:	192500 lbs counterweight comprising 1 basic slab of 27500 lbs and 6 slabs of 27500 lbs each.
Telescopic boom:	1 base section and 4 telescopic sections. All telescopic sections extendable individually by means of the rapid-cycle telescoping system TELEMATIK. Boom length 49 ft to 197 ft.
Electric system:	Modern data bus technique, 24 Volt DC, 2 batteries of 170 Ah each.

Complementary equipment.

Guying system for telescopic boom:	Consisting of guying frame with rope winch, tiltable in transport condition.
Additional ballast:	2 additional counterweight slabs of 27500 lbs each for a total counterweight of 247500 lbs, required for the operation with guyed telescopic boom.
Folding jibs:	Single folding jib, 40 ft long, for mounting on telescopic boom at 0°, 20° or 40°. Double folding jib, 40 ft to 69 ft long, for mounting on telescopic boom at 0°, 20° or 40°.
Lattice jibs:	Fixed lattice jib 46 ft to 161 ft long, luffing lattice jib 57 ft to 230 ft long.
2nd hoist gear:	For 2-hook operation or luffing of lattice jib.
Drive 12 x 8:	Axle 2 additionally driven.

Further equipment available on request.

Châssis porteur.

LTM 1300/1

Châssis:	Fabrication Liebherr, construction en caisson indéformable, en acier à haute résistance à grains fins.
Stabilisateurs:	Quatre poutres horizontales télescopiques, avec vérins hydrauliques de calage verticaux et patins. Les caissons de poutres de calage avants sont situés entre les essieux 2 et 3, et les caissons des poutres de calage arrières sont situés à l'arrière du châssis. Surface de calage: 29' en long et 27'11" travers.
Moteur:	Diesel 8 cylindres, marque Liebherr, type D 9408 TI-E, refroidi par eau, puissance selon DIN 440 kw (598 ch) à 1900 rpm selon ECE-R 24.03 et ECE-R 49.02 (EURO III), couple max. 1915 lbs/ft à 1400 rpm. Réservoir à carburant: 158 gallons.
Boîte de vitesse:	Boîte automatique de marque Allison, type CLBT 755, avec convertisseur de couple et ralentisseur hydraulique intégré. Cinq rapports avants et 1 rapport arrière. Boîte de transfert avec blocage de différentiel et étage vitesses terrain.
Essieux:	Essieux spéciaux pour grue. Les 6 essieux sont suspendus. Les essieux 1 à 3, 5 et 6 sont directeurs. Les essieux 1, 5 et 6 sont des essieux planétaires, entraînés, différentiel intermédiaire à l'essieu 5, tous les essieux moteurs avec différentiel transversal.
Arbres articulés:	Tous les arbres articulés à denture étagée de 70°.
Suspension:	Tous les essieux sont suspendus hydropneumatiquement avec mise à niveau et équilibrage entre essieux automatiques. Egalisation de la charge par essieu entre essieux 1 + 2, 3 + 4 et 5 + 6. Suspension blocable hydrauliquement.
Pneumatiques:	12 roues à monte simple. Taille: 16.00 R 25
Direction:	Direction semi-bloc ZF, à double circuit, assistée hydrauliquement, avec pompe auxiliaire entraînée par un essieu.
Freins:	Frein de service: à double circuit assisté pneumatiquement, sur toutes les roues. Frein auxiliaire: par clapets sur échappement commandés avec le ralentisseur hydraulique, ralentisseur électrodynamique Telma (en option). Frein de secours et frein à main: par cylindres à ressorts sur les essieux 2 à 6.
Cabine:	Cabine spacieuse, en tôle d'acier, suspendue sur silent blocs, vitrage de sécurité, tableau de bord complet.
Installation électrique:	Technique moderne de transmission de données par BUS de données, courant continu 24 Volts, 2 batteries de 170 Ah chacune, éclairage conforme au code de la route.

Partie tournante.

Châssis:	Construction mécanosoudée en tôle d'acier à haute résistance à grains fins. Reliée au porteur par une couronne d'orientation à 3 rangées de rouleaux. Rotation totale 360°.
Moteur:	Diesel 4 cylindres, marque Liebherr, type D 924 TI-E, refroidi par eau, puissance DIN 180 kw (245 ch) à 1800 rpm, couple max. 770 lbs/ft à 1100 rpm. Réservoir à carburant: 79 gallons.
Entraînement:	Diesel hydraulique à 3 pompes à débit variable servo commandées à régulation de puissance.
Commande:	2 leviers à 4 directions avec rappel automatique au point mort. Commande des mouvements progressive en continu par variation de l'inclinaison des pompes et augmentation du régime moteur.
Treuil:	Moteur hydraulique à cylindrée variable, treuil de marque Liebherr avec réducteur planétaire à frein d'arrêt à lamelles intégrées.
Relevage de flèche:	2 vérins hydrauliques différentiels avec clapets anti-retour de sécurité.
Orientation:	Un moteur hydraulique, un réducteur planétaire, un pignon d'orientation et un frein à lamelles.
Cabine de grue:	Cabine spacieuse, en tôle d'acier, avec vitrage de sécurité, tous les instruments de commande et de contrôle. Cabine inclinable, tournée sur l'arrière de la grue en position route.
Sécurité:	Contrôleur de charge LICCON, système test, fin de course crochet haut, clapets de sécurité en cas de ruptures de flexibles.
Contrepoids:	192500 lbs, composé d'une plaque de base de 27500 lbs et 6 plaques de 27500 lbs unitaires.
Flèche télescopique:	Un élément de base et de 4 télescopes. Chaque partie peut être télescopée individuellement à l'aide du système de télescopage séquentiel rapide TELEMATIK. Longueur de flèche: 49 ft – 197 ft.
Circuit électrique:	Technique moderne de transmission de données par BUS de données. Courant continu 24 Volts, 2 batteries de 170 Ah chacune.

Equipement optionnel.

Haubanage de flèche:	Composé du chevalet et du treuil.
Contrepoids complémentaire:	2 plaques complémentaires de 27500 lbs, pour une masse totale de 247500 lbs, pour travail en télescope haubané.
Fléchettes pliante:	Fléchette pliante, 40 ft, pour le montage à la flèche télescopique à 0°, 20° ou 40°. Fléchette pliante double, 40 ft à 69 ft, pour montage à la flèche télescopique à 0°, 20° ou 40°.
Fléchettes:	Fléchette fixe de 46 ft à 161 ft; fléchette à volée variable de 57 ft à 230 ft.
Deuxième treuil:	Pour le travail avec 2 crochets ou le relevage de la fléchette treillis.
Entraînement 12 x 8:	3ème essieu est entraîné additionnellement.

Autres équipement supplémentaires sur demande.

Subject to modification. / Sous réserve de modifications.

TP 278 US. 11.99

Please contact

Veuillez prendre contact avec

LIEBHERR-WERK EHINGEN GMBH

D-89582 Ehingen/Donau, Telefon (0 73 91) 5 02-0, Telefax (0 73 91) 5 02-3 99

www.lwe.liebherr.de, E-mail: info@lwe.liebherr.com

CD-